



1011

consumer pricelist
indoor & outdoor
april 2026

joli

GHEKIERE INDUSTRIES NV
Industrielaan 5, 8520 Kurne, Belgium - T +32 (0) 56 37 27 16
info@joli.be - www.joli.be

Price list € / Prijslijst € / Liste de prix €
Transport costs:
Benelux: franco
France & Germany: € 200 ≤ € 3.000 net
Other countries: on demand
Prices are subjected to change without prior notice.

Arcs	6
Central	12
Chagall	18
Collins	20
Curve	22
Fizz	28
Flower	34
Layers	36
Marguerite	38
Morisot	46
Nido	50
Olivo	52
Propeller	56
Pulse	58
Rafael	62
Sepia	66
Tendo	68
Wire	70
Table accessories	80
Ceramics	82
Wood	84
Frames	85
Fabrics - indoor	86
Fabrics - indoor & outdoor	88

arcs dining tables

indoor & outdoor

designed by Jeffrey Huyghe

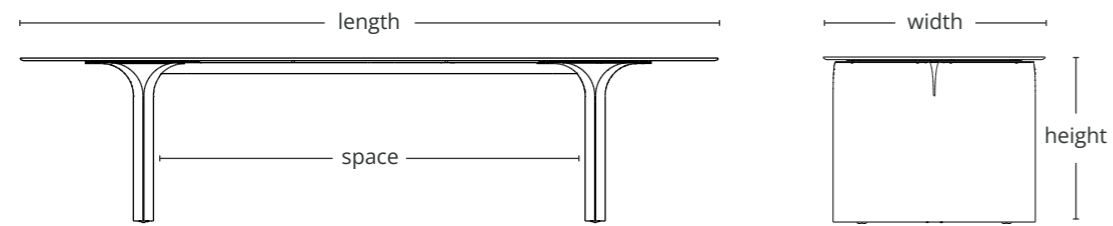

oval table

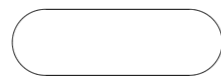

length	width	height	space	seats*	quantity / box / table	volume (m ³)	weight (kg)	€	
								ceramic top	wooden top
318	100	75	206	8 - 10	4	0.9	88	12 mm (sn)	32 mm
260	100	75	148	6 - 8	4	0.8	71	6.730	9.760
230	100	75	128	4	4	0.8	62	6.420	8.680
								6.100	8.500

faux elypt table



length	width	height	space	seats*	quantity / box / table	volume (m ³)	weight (kg)	€
								ceramic top
300	110	75	206	8	4	0.9	92	12 mm (sn)
250	110	75	148	6	4	0.8	76	6.730
220	110	75	128	4	4	0.8	67	6.420
								6.100

frame

alu + stainless steel



ceramic table top

matt

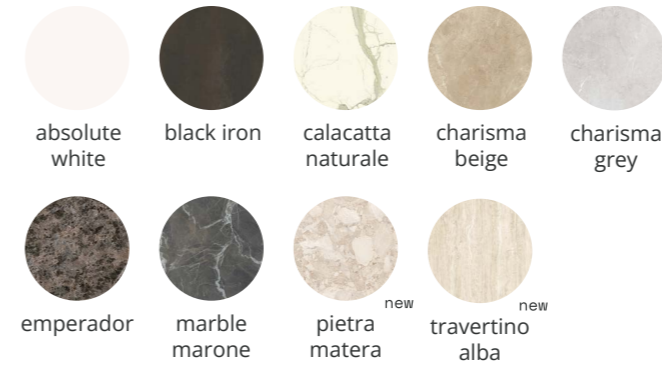

glossy

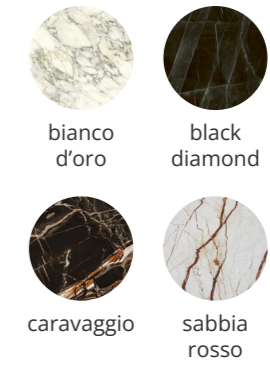

wooden top

indoor

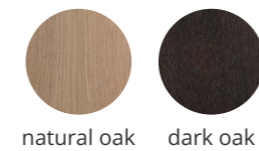

table top finish



+ packaging costs

- Outside the BENELUX, a mandatory charge applies of € 250 for a fumigated wooden crate.
- If this crate is not selected, the shipment will be at the customer's own risk and expense.

+ supplement

- Adjustment frame or top: closest standard dimension +15%.
- Adjustment frame and top: closest standard dimension +25%.
- Height not adjustable.

arcs coffee tables

indoor & outdoor

designed by Jeffrey Huyghe

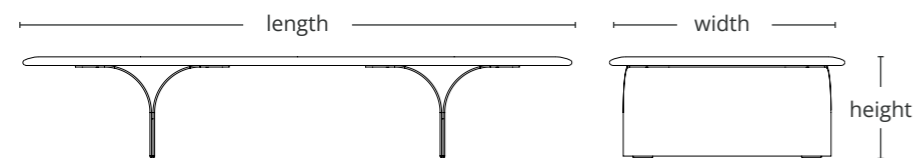

oval coffee table



length	width	height	quantity / box / table	volume (m ³) ceramics / wood	weight (kg) ceramics / wood	€	
						ceramic top 12 mm (sn)	wooden top 20 mm
160	70	26	2	0,17 / 0,19	44 / 38	3.350	4.600
140	60	26	2	0,17 / 0,18	38 / 30	3.350	4.600

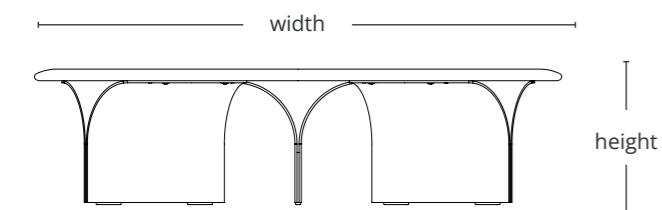

round coffee table



width	height	quantity / box / table	volume (m ³) ceramics / wood	weight (kg) ceramics / wood	€	
					ceramic top 12 mm (sn)	wooden top 20 mm
100	26	3	0,17 / 0,18	35 / 27	3.400	4.300

frame

alu + stainless steel



ceramic table top

matt

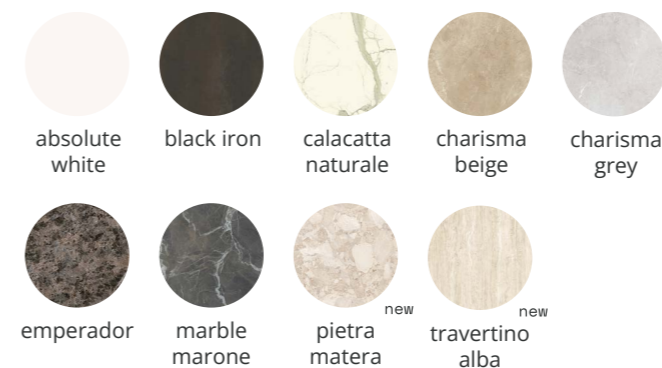

glossy

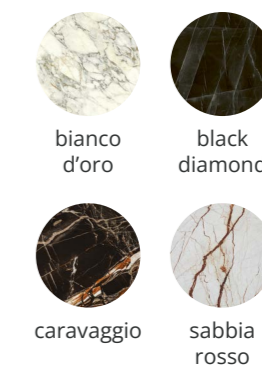

wooden top

indoor

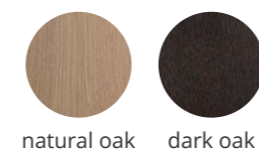

table top finish



+ packaging costs

- Outside the BENELUX, a mandatory charge applies of € 100 for a fumigated wooden crate.
- If this crate is not selected, the shipment will be at the customer's own risk and expense.

+ supplement

- Adjustment frame or top: closest standard dimension +15%.
- Adjustment frame and top: closest standard dimension +25%.
- Height not adjustable.

arcs bench

designed by Jeffrey Huyghe

indoor

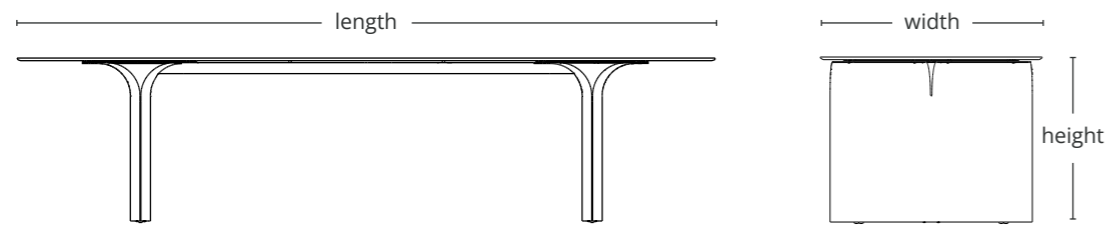

bench							€
length	width	height	suitable with oval table	quantity / box / table	volume (m ³)	weight (kg)	wooden top 20 mm
268	40	43,5	318	3	0,15	32	4.550
210	40	43,5	260	3	0,14	26	3.875
180	40	43,5	230	3	0,14	24	3.675
150	40	43,5		3	0,13	21	3.475

frame

alu + stainless steel

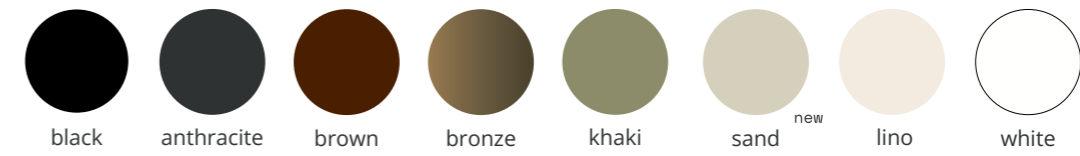

wooden top

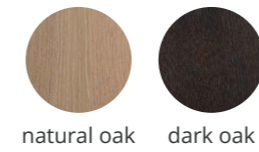
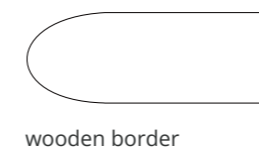

table top finish



+ packaging costs

- Outside the BENELUX, a mandatory charge applies of € 250 for a fumigated wooden crate.
- If this crate is not selected, the shipment will be at the customer's own risk and expense.

+ supplement

- Adjustment frame or top: closest standard dimension +15%.
- Adjustment frame and top: closest standard dimension +25%.
- Height not adjustable.

central big dining tables

indoor & outdoor

designed by Mathias De Ferm

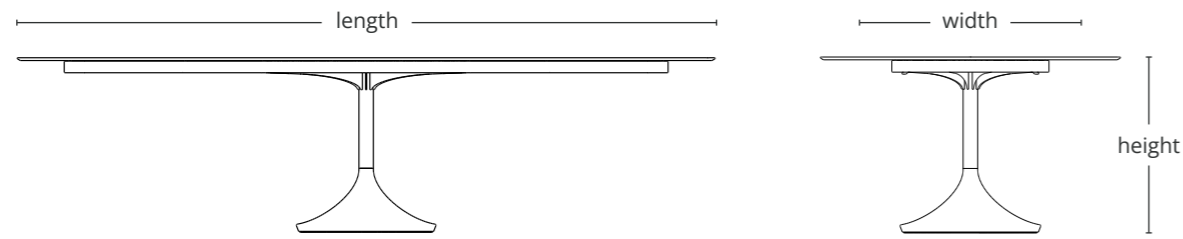

elyps

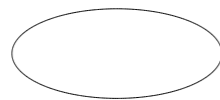

length	width	height	seats*	quantity / box / table	volume (m ³)	weight (kg)	€ ceramic top 12 mm (sn)
300	128	75	8 - 10	9	1.2	275	9.350
250	128	75	6 - 8	9	1.2	265	9.150
210	128	75	6	9	1.2	258	8.950

faux elyps

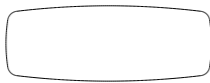

length	width	height	seats*	quantity / box / table	volume (m ³)	weight (kg)	€ ceramic top 12 mm (sn)	€ wooden top 32 mm
300	110	75	10	9	1.2	275	9.590	12.500
250	110	75	8	9	1.2	265	9.390	10.990
220	110	75	6 - 8	9	1.2	258	9.190	on demand

round

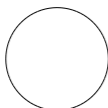

length	width	height	seats*	quantity / box / table	volume (m ³)	weight (kg)	€ ceramic top 12 mm (sn)
158	158	75	7 - 8	9	1.2	255	8.250

faux carre

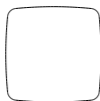

dia	height	seats*	quantity / box / table	volume (m ³)	weight (kg)	€ ceramic top 12 mm (sn)
158	75	6 - 8	9	1.2	255	8.250

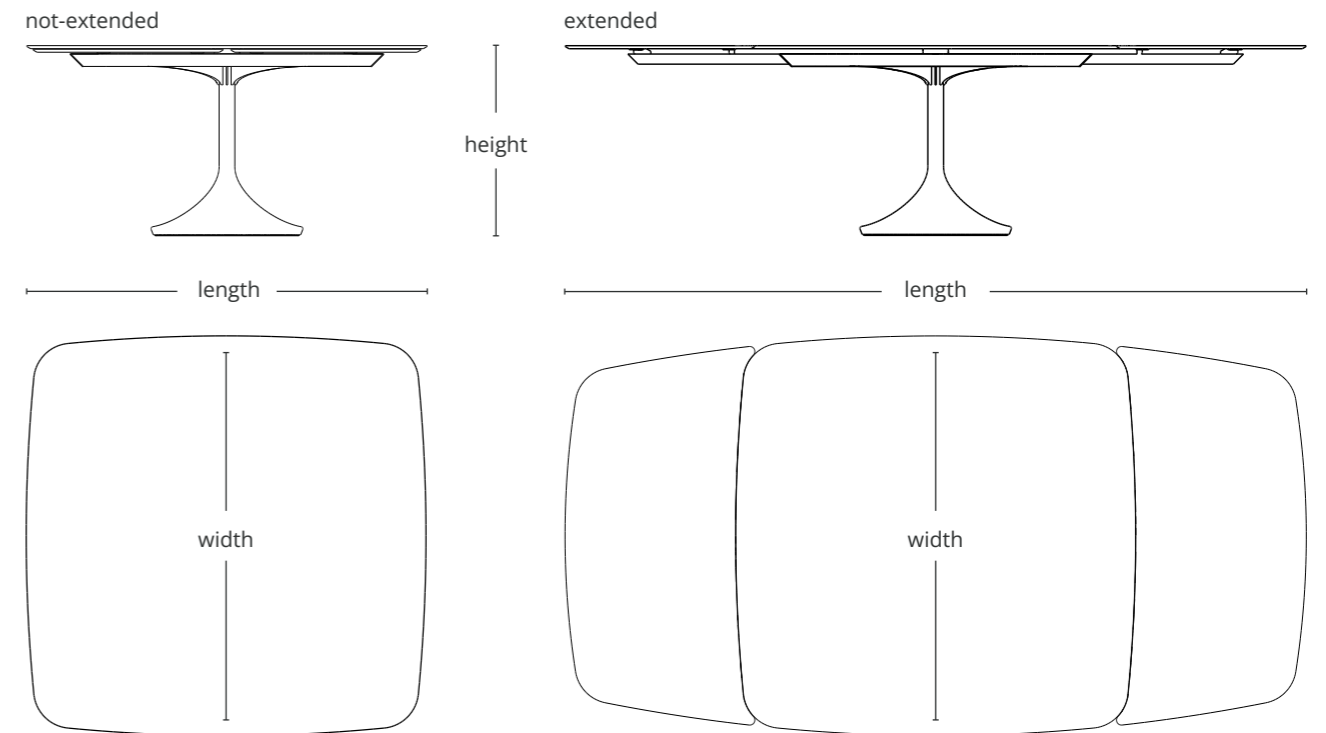

faux carré extensible

length not-extended	length extended	width	height	seats* not-extended	seats* extended	quantity / box / table	volume (m ³)	weight (kg)	€ ceramic top 12 mm (sn)
158	293	158	75	8	10 - 12	9	0,7	315	13.500

central dining tables

indoor & outdoor

designed by Mathias De Ferm

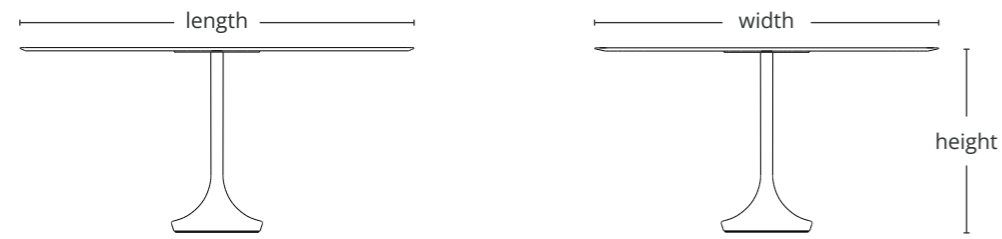

elyps single base

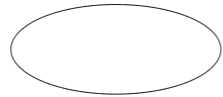

length	width	height	seats*	quantity / box / table	volume (m ³)	weight (kg)	€	
							ceramic top	12 mm (sn)
160	90	75	4	2	0.5	81	4.040	
160	70	75	2-4	2	0.5	72	3.930	

round single base

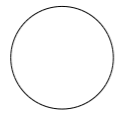

	width	height	seats*	quantity / box / table	volume (m ³)	weight (kg)	€	
							ceramic top	wooden top
							12 mm (sn)	20 mm
high	120	90	4-5	2	0.5	82	4.325	5.400
	100	90	4	2	0.5	72	4.220	4.990
normal	140	75	6-8	2	0.5	64	4.610	-
	120	75	5-6	2	0.5	54	4.325	5.400
	100	75	4-5	2	0.5	50	4.220	4.990
low	140	66	5-6	2	0.5	64	4.610	-
	120	66	4-5	2	0.5	54	4.325	5.400
	100	66	4	2	0.5	50	4.220	4.990

frame

central big tables: alu + stainless steel
dining tables: metalised cast iron + stainless steel



ceramic table top

matt

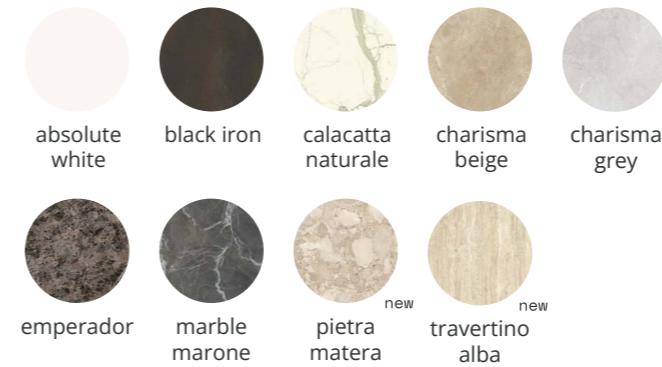

glossy

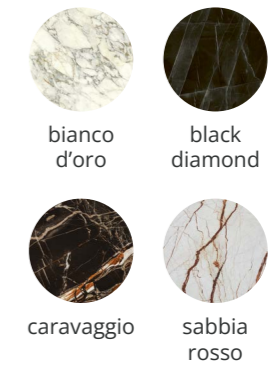

wooden top

indoor

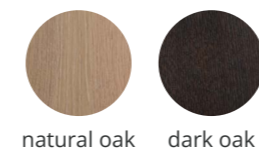

table top finish



+ packaging costs

- Outside the BENELUX, a mandatory charge applies for a fumigated wooden crate.
 - For dining tables, the charge is € 250.
 - Except Dining Round Single Base, for which the charge is € 150.
- If this crate is not selected, the shipment will be at the customer's own risk and expense.

+ supplement

- Adjustment frame or top: closest standard dimension +15%.
- Adjustment frame and top: closest standard dimension +25%.
- Height not adjustable.

central coffee tables

designed by Mathias De Ferm

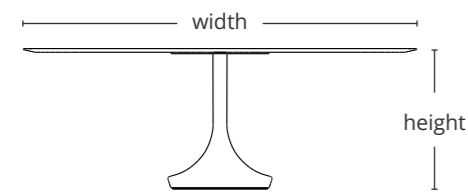

coffee table round

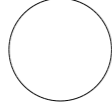

width	height	quantity / box / table	volume (m ³)	weight (kg)	€	
					ceramic top 12 mm (sn)	wooden top 20 mm
100	30	2	0.5	30	2.320	on demand
80	40	2	0.5	26	1.820	on demand
60	50	2	0.5	20	1.580	on demand

indoor & outdoor

frame

coffee tables: stainless steel



ceramic table top

matt

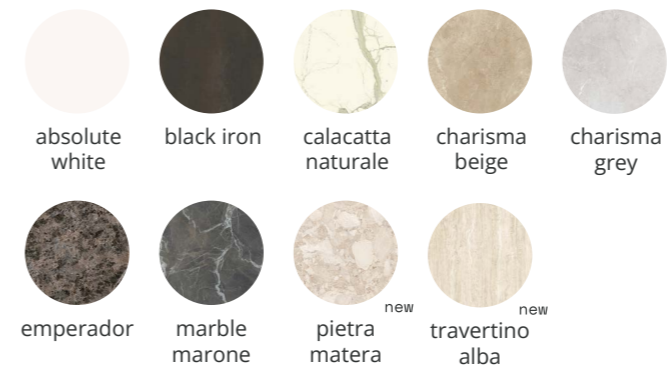

glossy

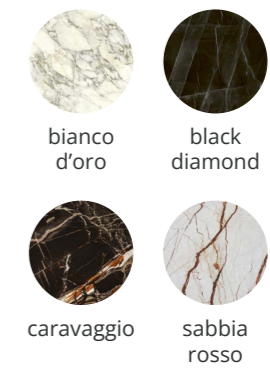
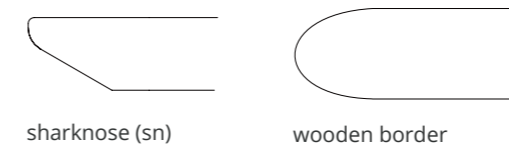

table top finish



+ packaging costs

- Outside the BENELUX, a mandatory charge of € 100 applies for a fumigated wooden crate.
- If this crate is not selected, the shipment will be at the customer's own risk and expense.

+ supplement

- Adjustment frame or top: closest standard dimension +15%.
- Adjustment frame and top: closest standard dimension +25%.
- Height not adjustable.

chagall chairs

designed by John Ghekiere

indoor

central base

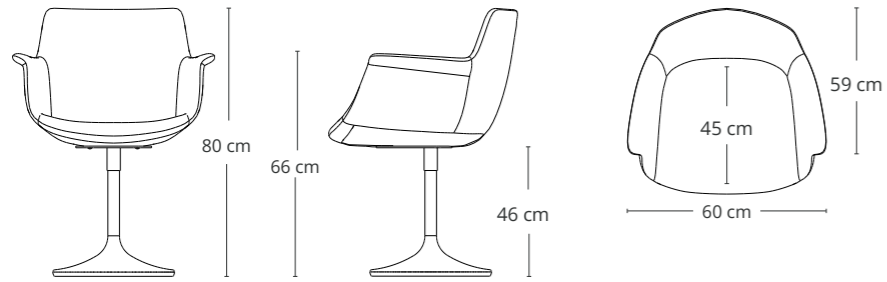

sled base

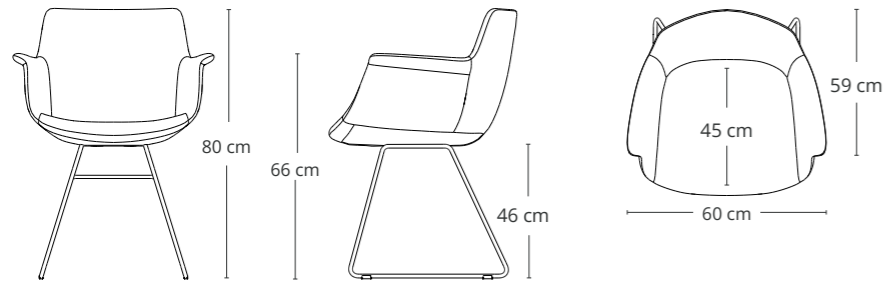

spinning

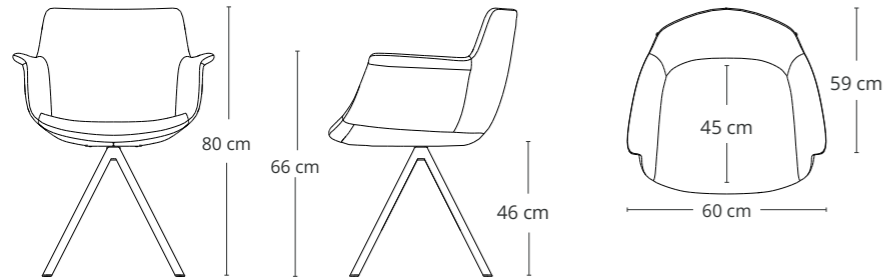

x-base

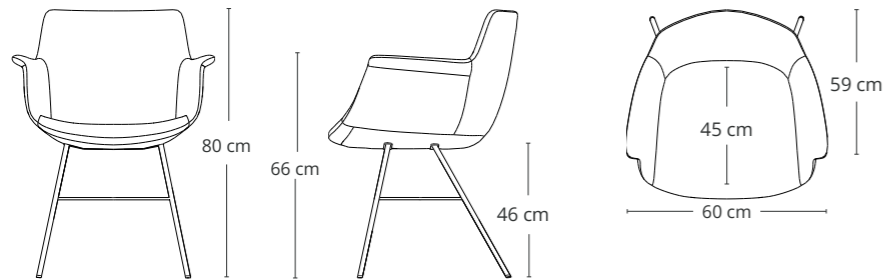

price

	quantity / box	volume (m ³)	weight / box (kg)	€			
				cibo smooth velvet	easy care	leather	vegan leather
central base	2	0.3	11	940	845	1.050	800
sled base	2	0.3	11	705	610	810	565
spinning	2	0.3	11	780	685	885	640
x-base	2	0.3	10	705	610	810	565

frame

metal lacquered



fabrics

cibo



smooth



velvet

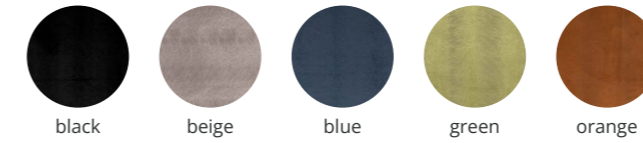

easy care

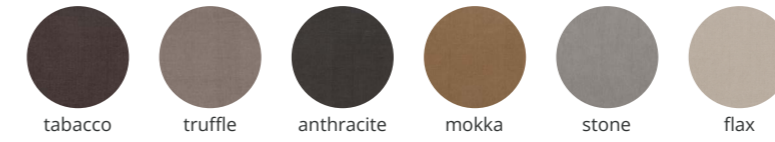

leather*



vegan leather



collins side tables

indoor & outdoor

designed by Mathias De Ferm

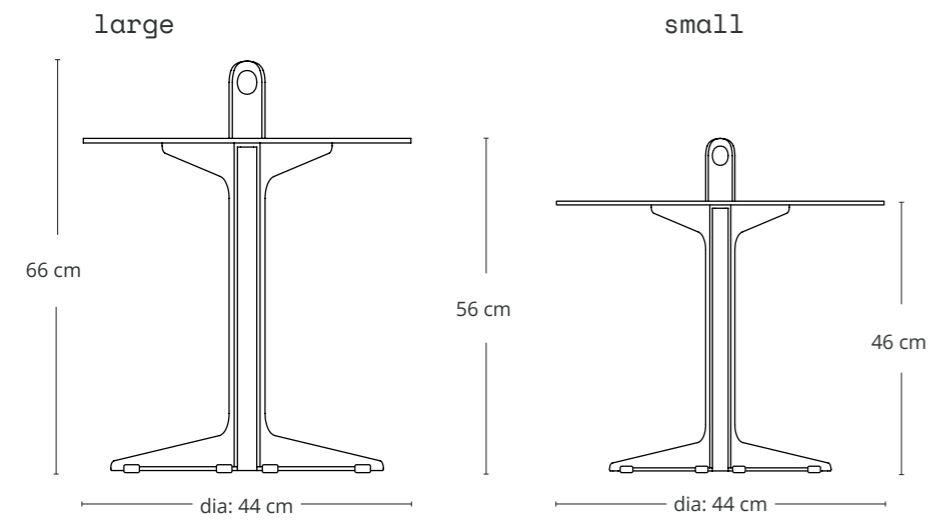

	quantity / box / table	volume (m ³)	weight (kg)	€ lacquered aluminium
large	1	0.13	5	490
small	1	0.13	4	470

frame

lacquered aluminium



curve chairs

designed by John Ghekiere

indoor & outdoor

armchair

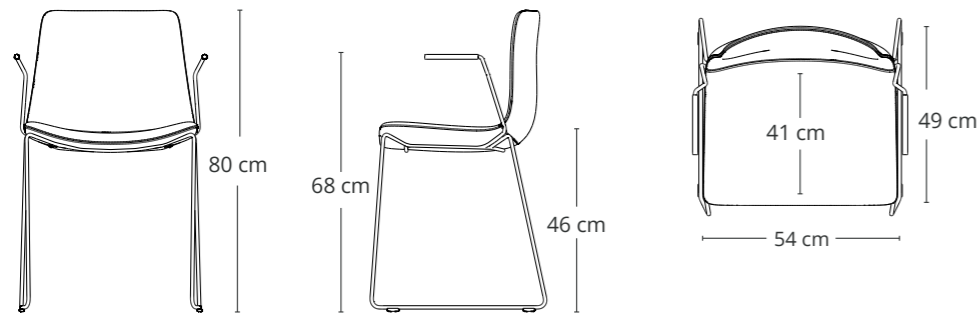

chair

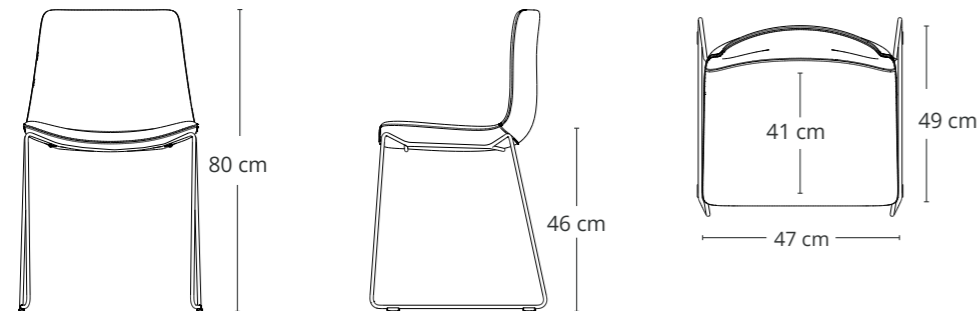

price

	quantity / box	volume (m³)	weight / box (kg)	€				
				cibo velvet	indoor easy care	indoor vegan leather	indoor & outdoor smooth	indoor & outdoor nautic linen
armchair - indoor	2	0,29	17,5	725	615	575	675	-
armchair - outdoor	2	0,29	14,3	-	-	-	840	815
chair - indoor	2	0,29	17,5	655	575	520	570	-
chair - outdoor	2	0,29	14,8	-	-	-	815	765

frame

indoor: metal frame lacquered
 outdoor: stainless steel frame lacquered



fabrics

cibo

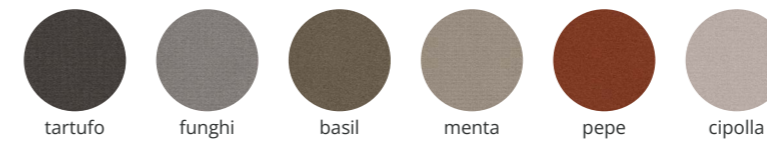

velvet

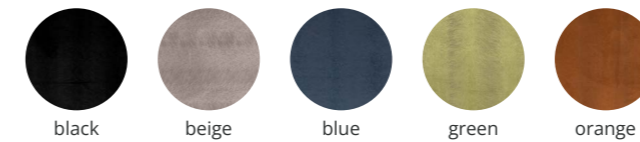

easy care

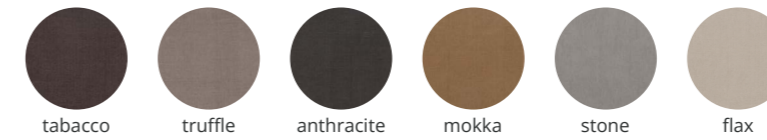

vegan leather

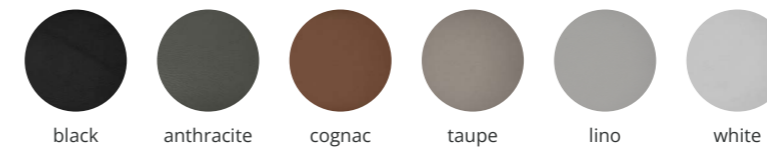

smooth



nautic linen

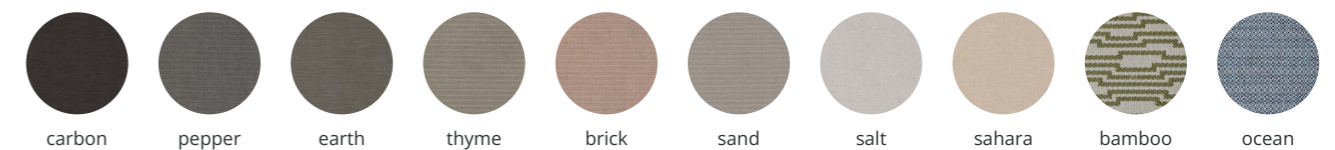

indoor & outdoor

indoor & outdoor

curve dining tables

indoor & outdoor

designed by John Ghekiere

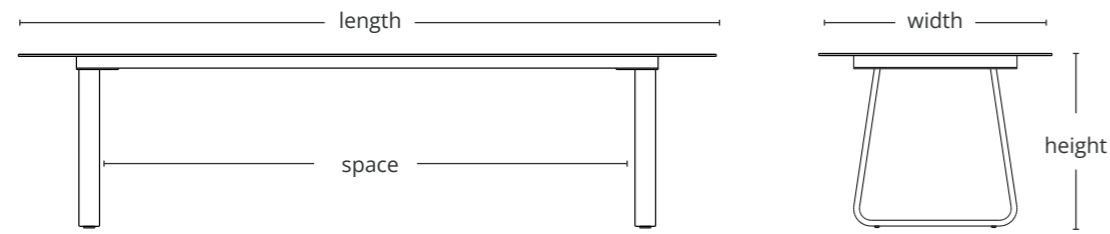

rectangular



length	width	height	space	seats*	quantity / box / table	volume (m ³)	weight (kg)	€ ceramic top	
								12 mm (nb)	12 mm (sn)
300	100	75	230	8 - 10	4	0.5	125	5.105	5.420
250	100	75	180	8	4	0.5	95	4.955	5.265
220	100	75	150	6 - 8	4	0.5	92	4.865	5.180
200	100	75	138	6 - 8	4	0.5	84	4.180	4.490
180	90	75	110	6	4	0.5	73	4.095	4.415

rectangular extendable



length	width	height	space	seats*	quantity / box / table	volume (m ³)	weight (kg)	€ ceramic top
								12 mm (nb)
215 - 315	100	75	180	6 - 10	4	0.5	125	5.975
160 - 240	100	75	136	6 - 8	4	0.5	95	5.830

faux elyps



length	width	height	space	seats*	quantity / box / table	volume (m ³)	weight (kg)	€ ceramic top
								12 mm (sn)
300	110	75	230	10	4	0.5	128	5.490
250	110	75	180	8	4	0.5	97	5.265
220	110	75	150	6 - 8	4	0.5	95	5.020
200	110	75	138	6 - 8	4	0.5	87	4.865
180	100	75	110	6	4	0.5	76	4.395

faux elyps extendable



length	width	height	space	seats*	quantity / box / table	volume (m ³)	weight (kg)	€ ceramic top
								12 mm (nb)
220 - 320	110	75	180	6 - 10	6	0.63	120	7.350
165 - 245	110	75	136	6 - 8	6	0.44	120	7.130

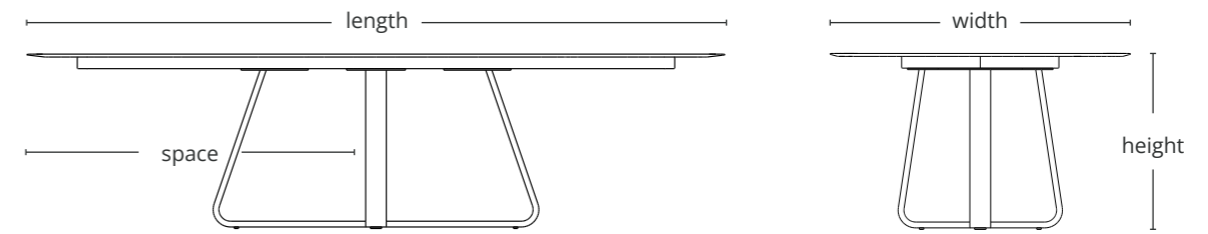

elyps

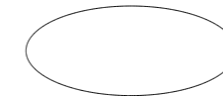

length	width	height	space	seats*	quantity / box / table	volume (m ³)	weight (kg)	€ ceramic top	
								12 mm (nb)	12 mm (sn)
300	128	75	140	8 - 10	3	0.5	137	6.905	7.130
250	128	75	140	6 - 8	3	0.5	121	6.735	6.880
210**	128	75	140	6	3	0.5	109	6.325	6.615

** for this size, we use the same frame as in the 250 model, which may make the frame visible at the ends.

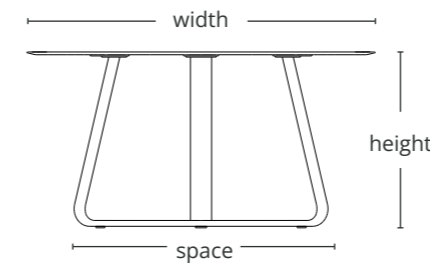

round

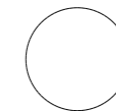

width	height	space	seats*	quantity / box / table	volume (m ³)	weight (kg)	€ ceramic top	
							12 mm (nb)	12 mm (sn)
150	75	109	6	2	0.4	82	4.235	4.235
120	75	83	4 - 5	2	0.4	76	3.695	3.695
100	75	66	4	2	0.3	65	3.470	3.470

* Depending on chair width

curve coffee tables

indoor & outdoor

designed by John Ghekiere

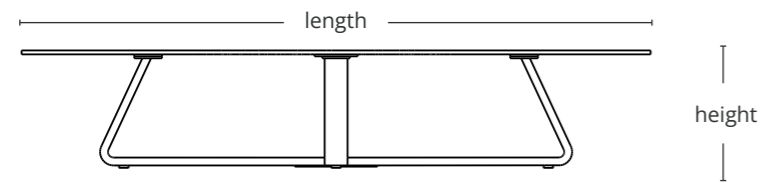

elyps

length	width	height	quantity / box / table	volume (m ³)	weight (kg)	€ ceramic top 12 mm (sn)
180	90	30	2	0.4	60	3.315
160	70	30	2	0.3	55	2.775
120	60	30	2	0.3	51	2.600

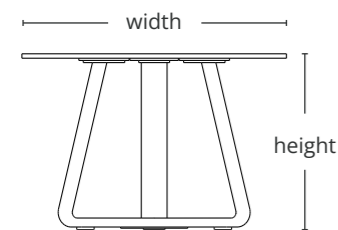

round

width	height	quantity / box / table	volume (m ³)	weight (kg)	€ ceramic top 12 mm (sn)
120	30	2	0.5	42	2.830
100	30	2	0.4	28	2.515
80	30	2	0.4	17	2.040
60	40	2	0.3	9	1.880
50	50	2	0.3	7	1.880

frame

dining tables: lacquered aluminium
 extendable dining tables: stainless steel lacquered (frame) + lacquered aluminium (legs)
 coffee tables: lacquered aluminium



ceramic table top

matt

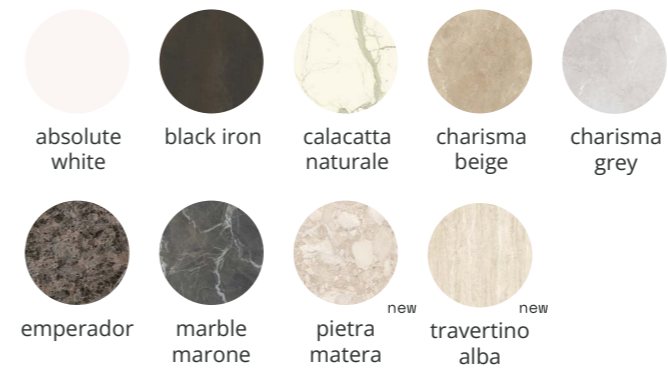

glossy

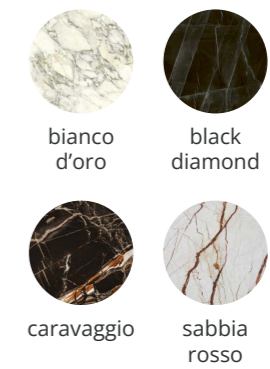
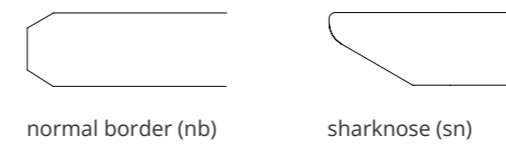

table top finish



+ packaging costs

Outside the BENELUX, a mandatory charge applies for a fumigated wooden crate.

- For dining tables, the charge is € 250.
- Except Dining Round (120 & 100 cm), for which the charge is € 150.
- For coffee tables, the charge is € 100.

If this crate is not selected, the shipment will be at the customer's own risk and expense.

+ supplement

- Adjustment frame or top: closest standard dimension +15%.
- Adjustment frame and top: closest standard dimension +25%.
- Height not adjustable.

fizz chairs

designed by Mathias De Ferm

indoor & outdoor

dining chair

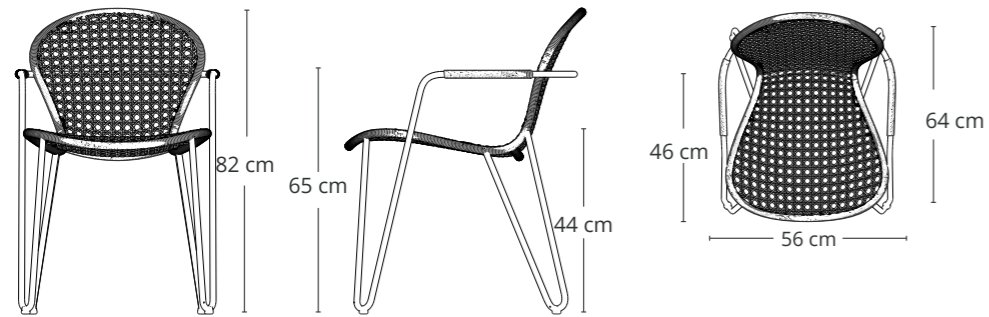

low chair

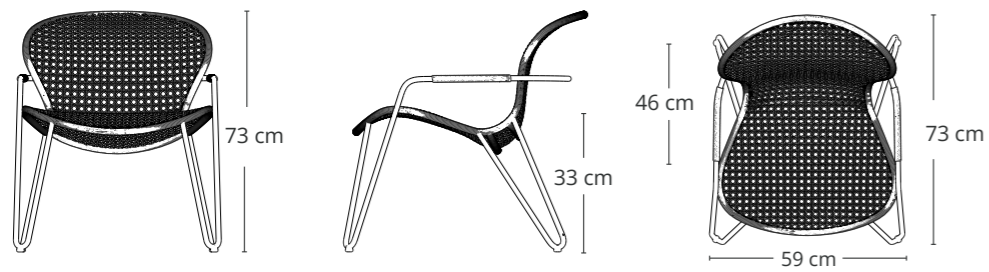

price

	quantity / box	volume (m ³)	weight / box (kg)	€			
				rope solemio	grain	smooth	nautic linen
dining chair	3	0.6	15	720	-	-	-
dining chair - cushion	10	0.1	2	-	175	175	140
low chair	2	0.6	18	820	-	-	-
low chair - cushion	10	0.1	2	-	195	195	155

rope solemio

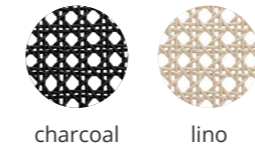

frame

lacquered aluminium

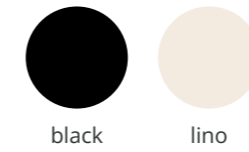

cushions

grain



smooth



nautic linen



fizz dining tables

designed by Mathias De Ferm

indoor & outdoor

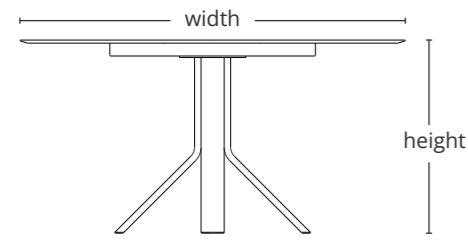

round

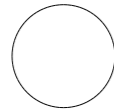

width	height	seats*	quantity / box / table	volume (m ³)	weight (kg)	€ ceramic top
						12 mm (nb/sn)
150	75	6 - 7	3	0,56	76	5.125
120	75	5	3	0,56	72	4.505

square



width	height	seats*	quantity / box / table	volume (m ³)	weight (kg)	€ ceramic top
						12 mm (nb/sn)
150	75	6 - 8	2	0,56	76	4.995
130	75	6	2	0,56	72	4.435

frame

lacquered aluminium



ceramic table top

matt

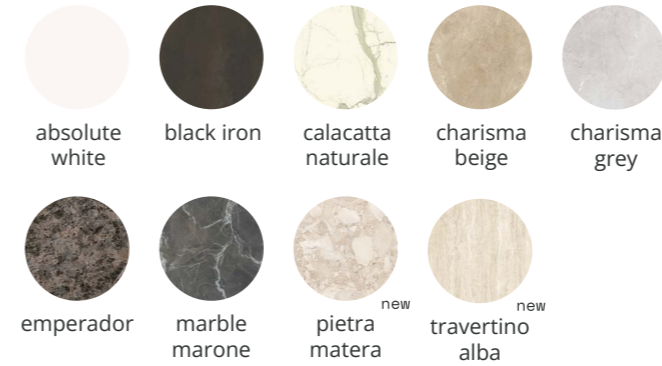

glossy

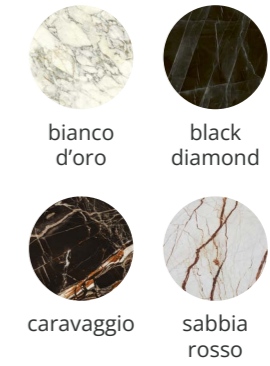
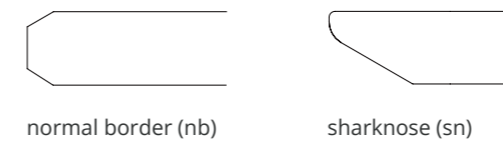

table top finish



+ packaging costs

Outside the BENELUX, a mandatory charge applies for a fumigated wooden crate.

- For the 150 cm dining tables, the charge is € 250.
- For the round 120 and square 130 cm dining tables, the charge is € 150.

If this crate is not selected, the shipment will be at the customer's own risk and expense.

fizz bistro tables

indoor & outdoor

designed by Mathias De Ferm

3-leg

foldable with click system

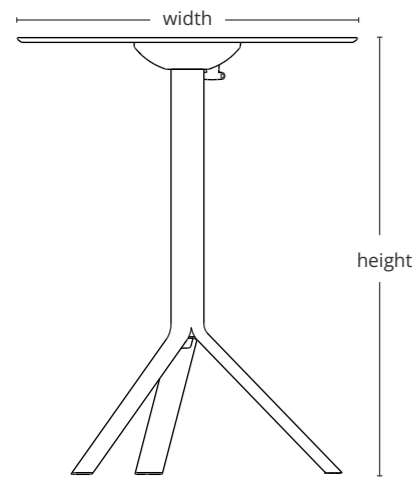

4-leg

non-foldable

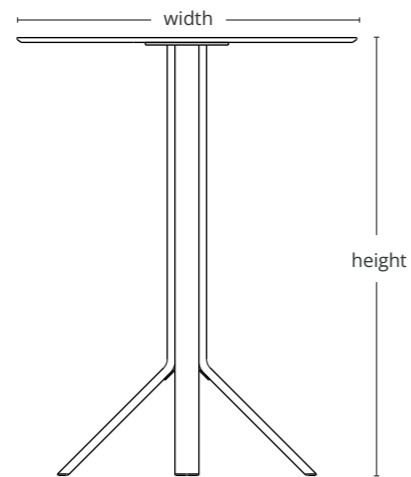

round

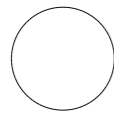

	width	height	seats*	quantity / box / table	volume (m³)	weight (kg)	€		
							lacquered aluminium	ceramic top	
							5 mm	12 mm (nb)	12 mm (sn)
3-legs	70	66 / 75	2	2	0,09	11	915	1.210	1.365
		90 / 110	2	2	0,1	13	970	1.260	1.420
	80	66 / 75	2-3	2	0,1	15	-	1.315	1.470
		90 / 110	2-3	2	0,1	17	-	1.365	1.525
4-legs	80	66 / 75	2-3	2	0,1	15	-	1.315	1.470
		90 / 110	2-3	2	0,1	17	-	1.365	1.525
	100	66 / 75	3-4	2	0,1	19	-	1.630	1.785
		90 / 110	3-4	2	0,1	21	-	1.680	1.840

square



	width	height	seats*	quantity / box / table	volume (m³)	weight (kg)	€		
							lacquered aluminium	ceramic top	
							5 mm	12 mm (nb)	12 mm (sn)
3-legs	70	66 / 75	2	2	0,09	11	915	1.210	1.365
		90 / 110	2	2	0,1	13	970	1.260	1.420
4-legs	80	66 / 75	2-3	2	0,1	15	-	1.315	1.470
		90 / 110	2-3	2	0,1	17	-	1.365	1.525

frame

lacquered aluminium

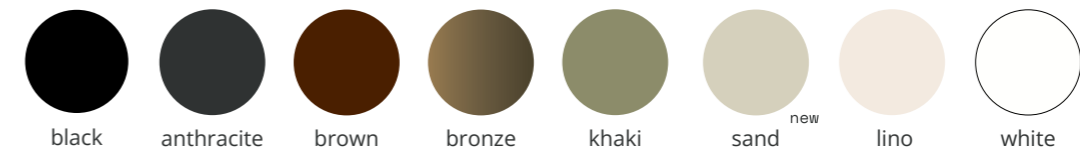

lacquered aluminium table tops

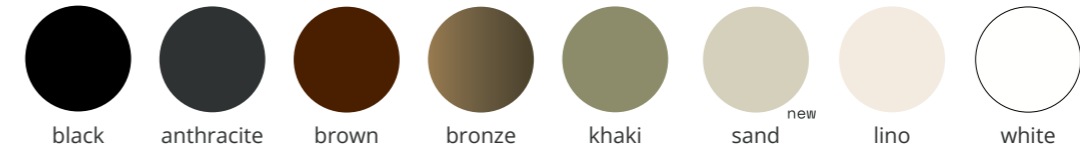

ceramic table top

matt

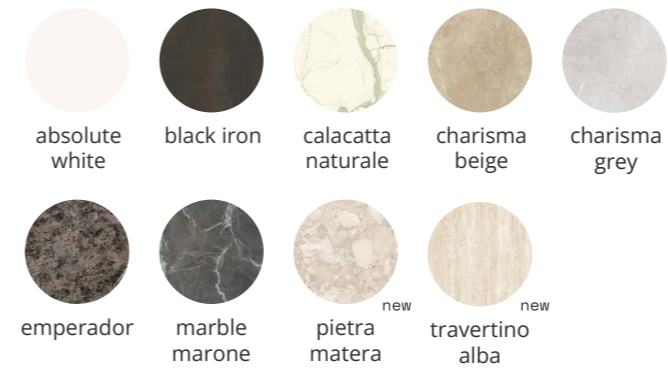

glossy

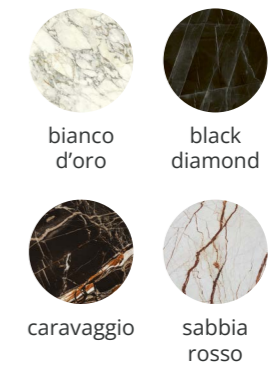
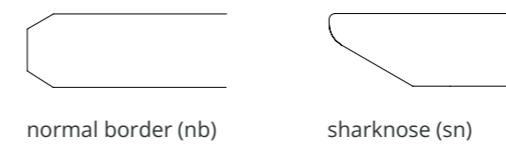

table top finish



+ packaging costs

- Outside the BENELUX, a mandatory charge of € 150 applies for a fumigated wooden crate.
- If this crate is not selected, the shipment will be at the customer's own risk and expense.

flower side tables

indoor & outdoor

designed by Mathias De Ferm

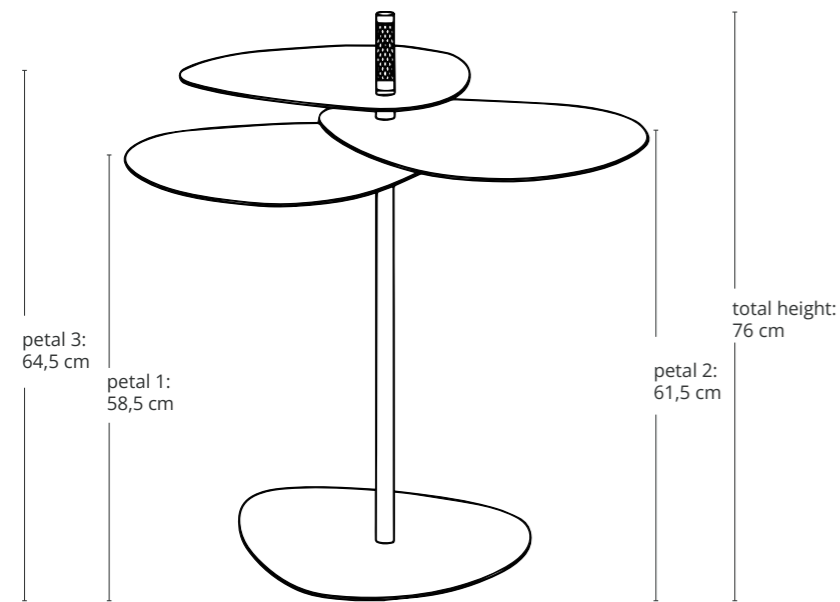

length petals	width petals	quantity / box / table	volume (m ³)	weight (kg)	€
45	40,5	1	0.15	12	880

frame

lacquered aluminium + stainless steel



layers tables

indoor & outdoor

designed by Sylvain Willenz

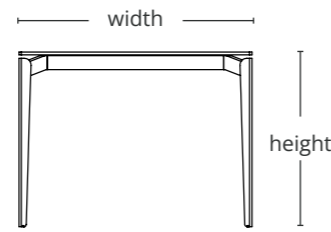
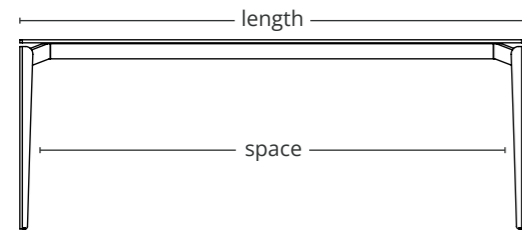

dining table

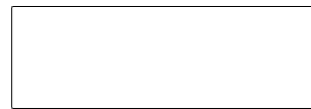

length	width	height	space	seats*	quantity / box / table	volume (m ³)	weight (kg)	€ ceramic top	
								12 mm (nb)	12 mm (sn)
300	100	75	289	8 - 10	3	0,3	124	5.650	5.900
250	100	75	239	8 - 10	3	0,3	108	5.150	5.400
220	100	75	209	8	3	0,3	94	4.750	4.990
200	100	75	189	8	3	0,3	88	4.275	4.525
180	90	75	169	6	3	0,3	80	4.200	4.450

wall table



length	width	height	quantity / box / table	volume (m ³)	weight (kg)	€ ceramic top	
						12 mm (nb)	12 mm (sn)
200	40	75	3	0,5	45	2.810	2.965
160	40	75	3	0,5	43	2.695	2.850

coffee table



length	width	height	quantity / box / table	volume (m ³)	weight (kg)	€ ceramic top	
						12 mm (nb)	12 mm (sn)
150	100	29	3	0,5	48	3.005	3.160
130	70	29	3	0,5	43	2.435	2.590
100	100	29	3	0,5	43	2.585	2.740

lamp table



length	width	height	quantity / box / table	volume (m ³)	weight (kg)	€ ceramic top	
						12 mm (nb)	12 mm (sn)
55	55	43	3	0,2	34	1.950	2.105

frame

dining tables: stainless steel lacquered
wall, coffee and lamp tables: lacquered aluminium



ceramic table top

matt

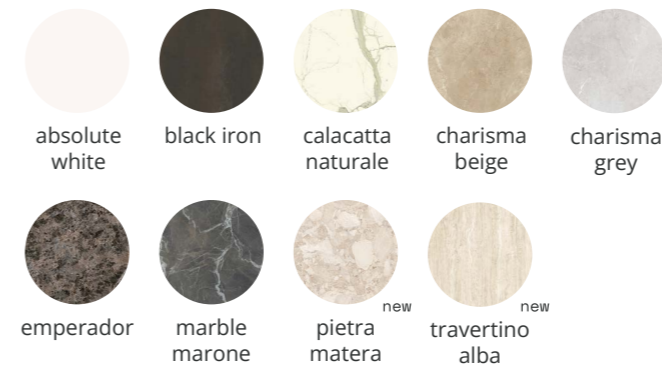

glossy

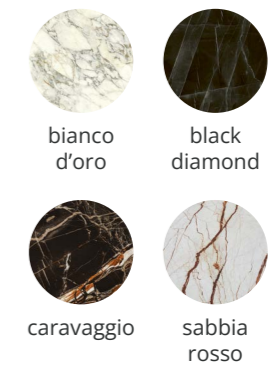
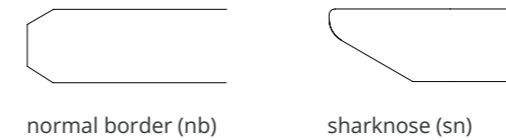

table top finish



+ packaging costs

Outside the BENELUX, a mandatory charge applies for a fumigated wooden crate.

- For dining tables, the charge is € 250.
- For the wall tables, the charge is € 150.
- For coffee and lamp tables, the charge is € 100.

If this crate is not selected, the shipment will be at the customer's own risk and expense.

+ supplement

- Adjustment frame or top: closest standard dimension +15%.
- Adjustment frame and top: closest standard dimension +25%.
- Height not adjustable.

marguerite chairs

indoor & outdoor

designed by Mathias De Ferm

armchair

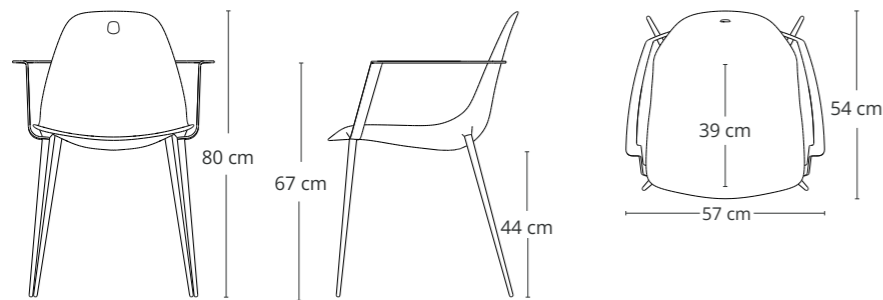

chair

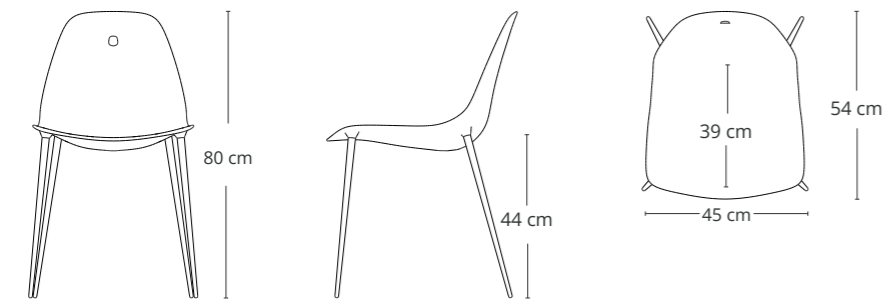

central base

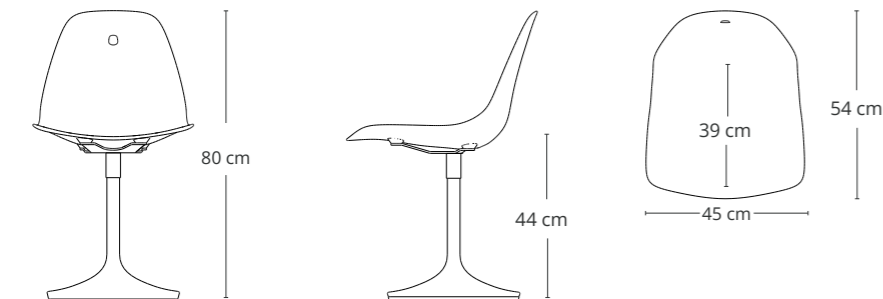

price

	quantity / box	volume (m ³)	weight / box (kg)	€					
				lacquered	velvet cibo	easy care	tanned leather	grain smooth	nautic linen
armchair	1	0.3	11	580	-	-	-	-	-
chair	2	0.4	15	430	-	-	-	-	-
chair - central base	1	0.3	11	825	-	-	-	-	-
shell	10	0.1	3	-	250	195	315	250	195
cushion	10	0.1	2	-	190	155	-	190	155

frame

lacquered aluminium



cushions/shells

cibo

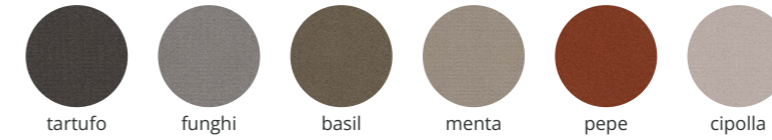

velvet

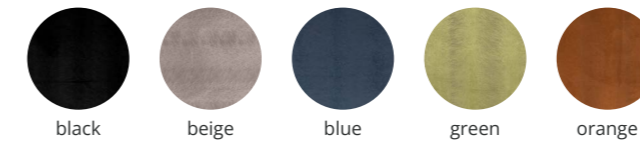

easy care

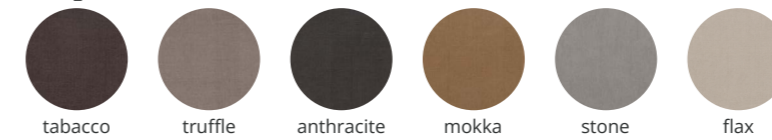

tanned leather *



grain



indoor & outdoor

smooth



indoor & outdoor

nautic linen

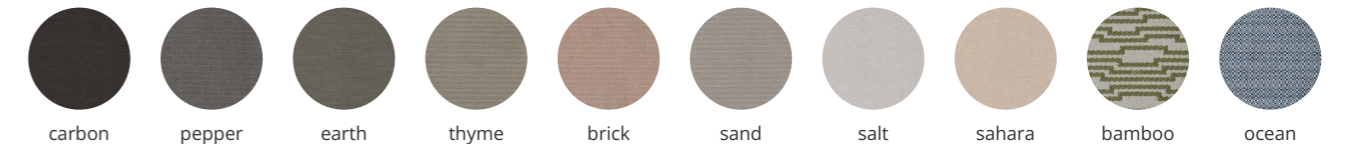

indoor & outdoor

optional

Caps for under chair legs with felt, for wooden floors (example: black armchair)
€ 40 per chair (€ 10 per leg)



marguerite lounger

designed by Mathias De Ferm

indoor & outdoor

lounger

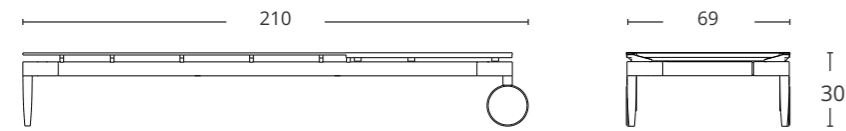

sofa

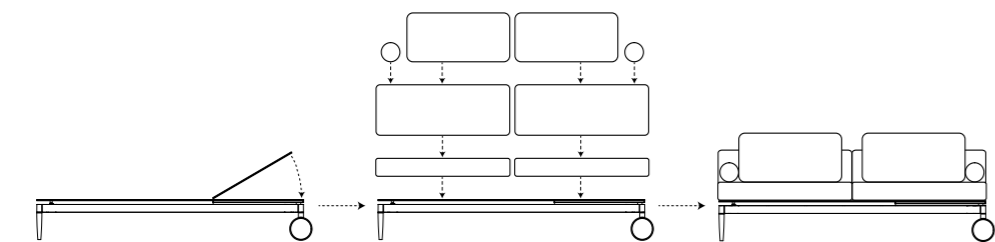
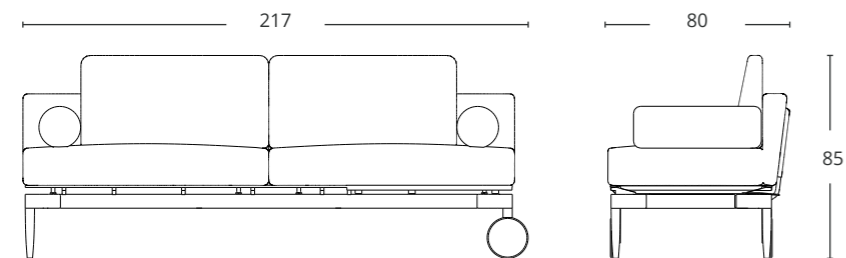

price

	quantity / box	volume (m³)	weight / box (kg)	€ indoor & outdoor		
				lacquered	grain smooth	nautic linen
lounger	1	0.5	46	2.595	-	-
lounger cushion with headrest	2	0.1	5	-	725	680
all sofa cushions				-	4.235	3.915
lounger incl. all sofa cushions, lounger cushion with headrest and protection covers*	2	0.9	56	-	6.830	6.510
cushion dia 35	10	0.1	2	-	160	130
cushion dia 45	10	0.1	2	-	175	145
cushion square (30 x 30)	10	0.1	2	-	160	130
cushion rectangular (50 x 50)	10	0.1	2	-	175	145

frame

lacquered aluminium + wheels



cushions

grain



smooth



nautic linen



* Set of cushions for 1 sofa: 2x seat cushion, 2x back cushions on steel fram (incl.), 2x back cushions with checked pattern, 2x rounded arm cushions with interior stainless steel plate, 2x storage covers for the cushions, 1x SurLast all-weather cover, 1x lounger cushion.

marguerite dining table

indoor & outdoor

designed by Mathias De Ferm

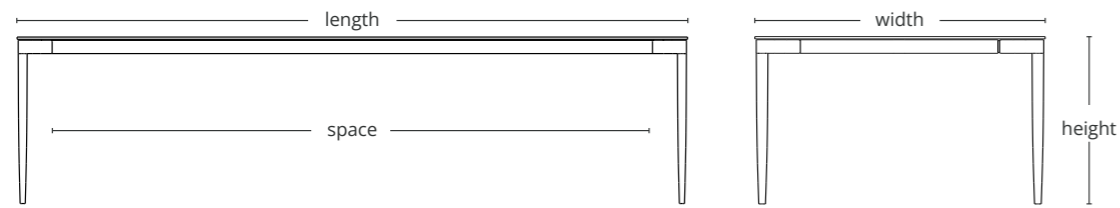

rectangular

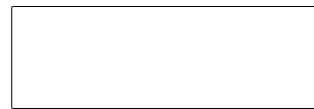

length	width	height	space	seats*	quantity / box / table	volume (m ³)	weight (kg)	€ ceramic top	
								12 mm (nb)	12 mm (sn)
300	100	75	289	8 - 10	3	0.3	120	4.665	4.925
250	100	75	239	8 - 10	3	0.3	100	4.340	4.600
220	100	75	209	8	3	0.3	88	4.290	4.550
200	100	75	189	8	3	0.3	80	3.695	3.955
180	90	75	169	6	3	0.3	70	3.640	3.900
140	90	75	130	6	3	0.3	56	3.520	3.780

rectangular extendable xxl-xl

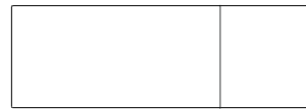

length	width	height	space	seats*	quantity / box / table	volume (m ³)	weight (kg)	€ ceramic top
								12 mm (nb)
200 - 260	100	75	190	8 - 10	4	0.4	130	5.650
160 - 220	100	75	150	6 - 8	4	0.4	120	5.015

square



width	height	space	seats*	quantity / box / table	volume (m ³)	weight (kg)	€ ceramic top	
							12 mm (nb)	12 mm (sn)
150	75	140	6 - 8	3	0.3	90	3.765	4.025
130	75	120	6	3	0.3	68	3.815	4.075
100	75	90	4	3	0.3	40	2.870	3.130

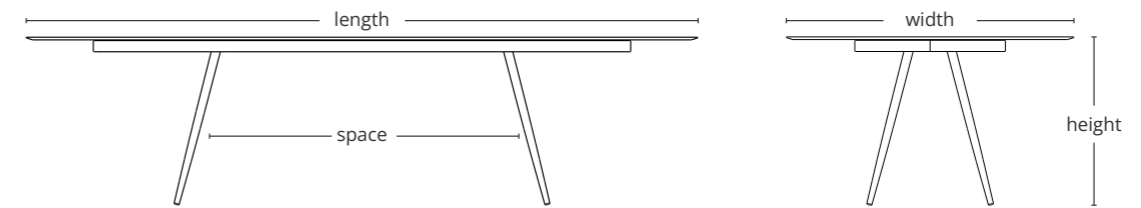

elyps

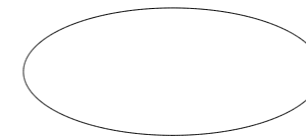

length	width	height	space	seats*	quantity / box / table	volume (m ³)	weight (kg)	€ ceramic top	
								12 mm (nb)	12 mm (sn)
300	128	74,5	165,7	8	3	0.3	117	4.645	4.905
250	128	74,5	127,7	6 - 8	3	0.3	102	4.365	4.625
210**	128	74,5	127,7	6	3	0.3	90	4.020	4.280

** For this size, we use the same frame as in the 250 model, which may make the frame visible at the ends.

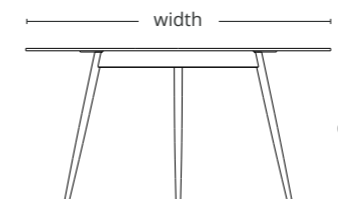

round

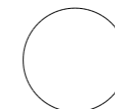

width	height	seats*	quantity / box / table	volume (m ³)	weight (kg)	€ ceramic top	
						12 mm (nb)	12 mm (sn)
150	75	5	2	0.3	78	2.795	3.055
120	75	4	2	0.3	54	2.375	2.635
100	75	3 - 4	2	0.3	41	1.910	2.170

marguerite coffee table

indoor & outdoor

designed by Mathias De Ferm

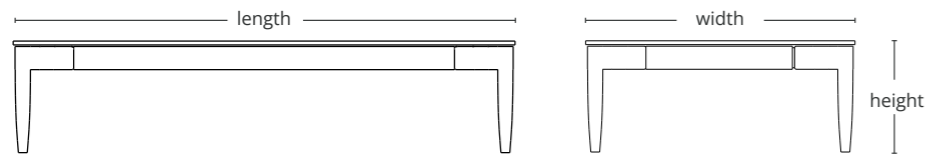

rectangular



length	width	height	space	quantity / box / table	volume (m³)	weight (kg)	€ ceramic top	
							12 mm (nb)	12 mm (sn)
130	70	32	120	3	0.3	35	2.055	2.210
100	100	32	90	3	0.3	35	2.055	2.210

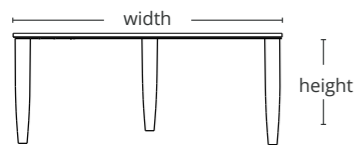

round

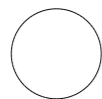

width	height	quantity / box / table	volume (m³)	weight (kg)	€ ceramic top
					12 mm (sn)
120	24 / 31 / 37	2	0,1	25	1.995
100	24 / 31 / 37	2	0,1	20	1.580
80	24 / 31 / 37	2	0,1	15	1.040
60	24 / 31 / 37	2	0,1	10	990
50	24 / 31 / 37	2	0,1	8	935

frame

lacquered aluminium

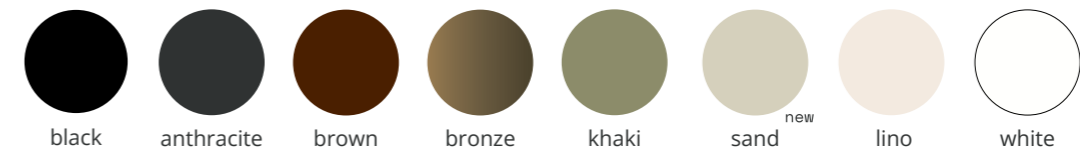

ceramic table top

matt

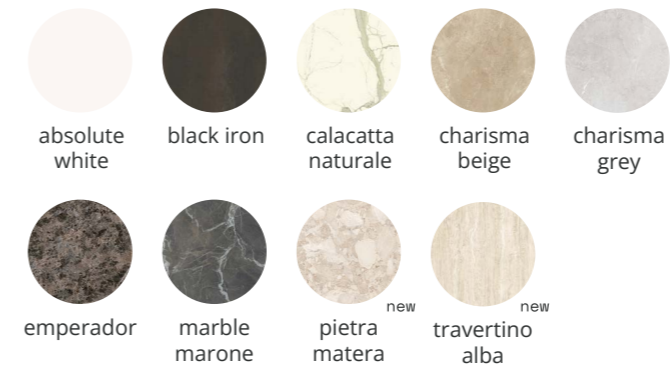

glossy

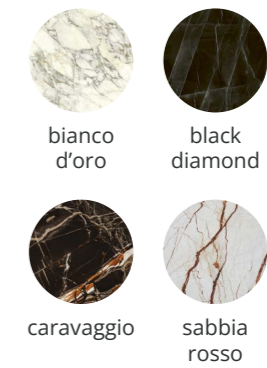
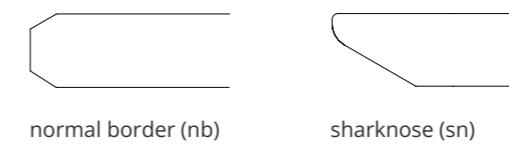

table top finish



+ packaging costs

Outside the BENELUX, a mandatory charge applies for a fumigated wooden crate.

- For dining tables, the charge is € 250.
- Except Dining Round (120 & 100 cm) and Dining Square (130 & 100 cm), for which the charge is € 150.
- For coffee tables, the charge is € 100.

If this crate is not selected, the shipment will be at the customer's own risk and expense.

+ supplement

- Adjustment frame or top: closest standard dimension +15%.
- Adjustment frame and top: closest standard dimension +25%.
- Height not adjustable.

morisot barstools

designed by John Ghekiere

indoor

sled base high & low

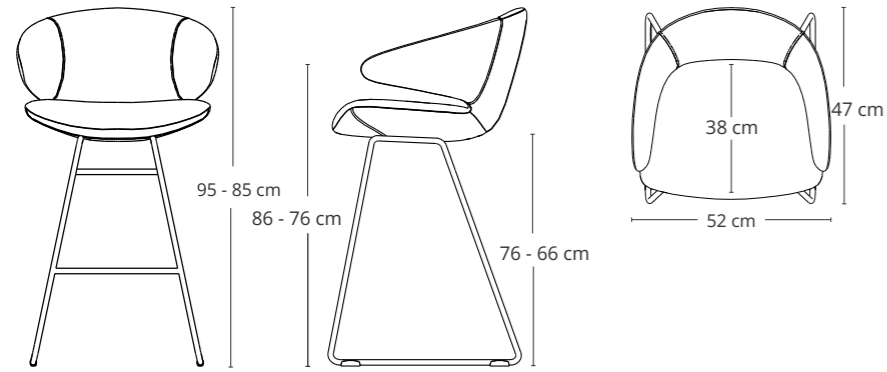

spider base low with auto-return

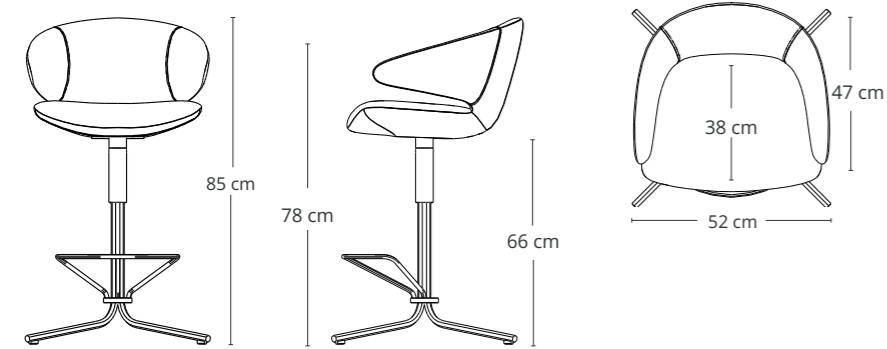

spinning base high & low

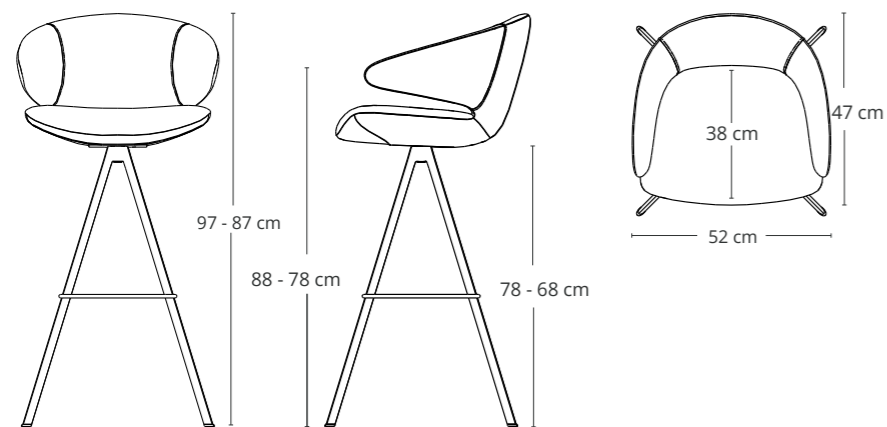

price

	quantity / box	volume (m³)	weight / box (kg)	€		
				cibo smooth velvet	easy care	leather
sled base - high	1	0.3	10	680	640	795
sled base - low	1	0.21	9	670	625	790
spider base - low	1	0.3	10	770	715	885
spinning - high	1	0.21	10	680	640	795
spinning - low	1	0.21	10	670	625	790

frame

metal frame lacquered



fabrics

cibo

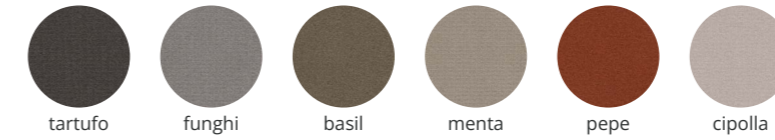

smooth



velvet

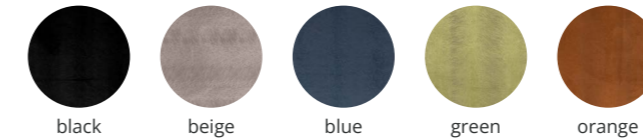

easy care

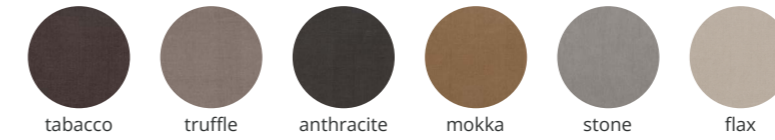

leather*

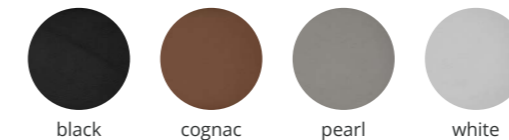

morisot chairs

designed by John Ghekiere

indoor

central base

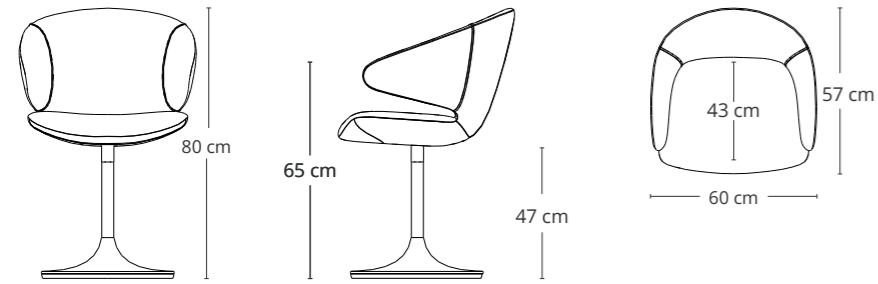

sled base

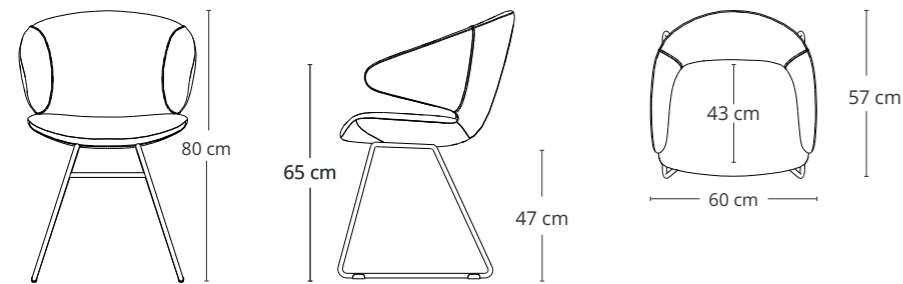

spider base

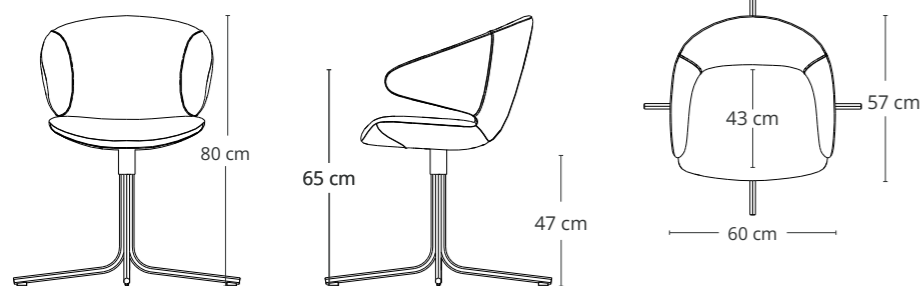

x-base

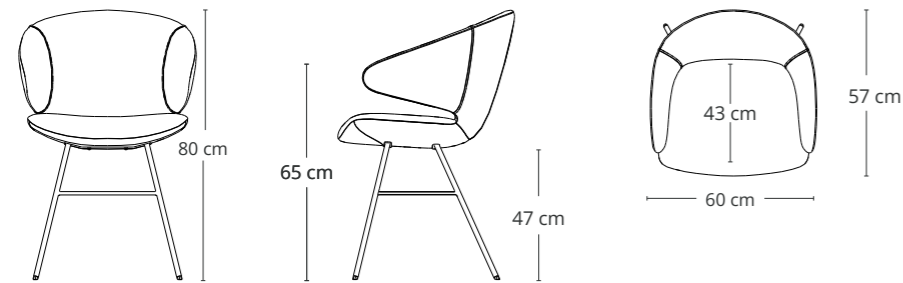

price

	quantity / box	volume (m ³)	weight / box (kg)	€		
				cibo smooth velvet	easy care	leather
central base	1	0.3	11	940	880	1.060
sled base	1	0.3	12	715	655	835
spider base	1	0.3	11	765	695	880
x-base	1	0.3	12	715	655	835

frame

metal frame lacquered



fabrics

cibo

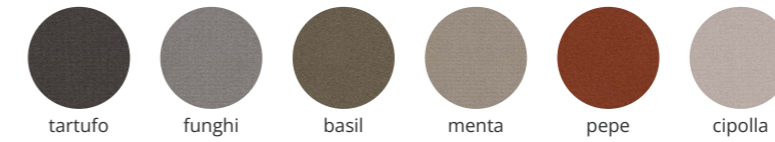

smooth



velvet

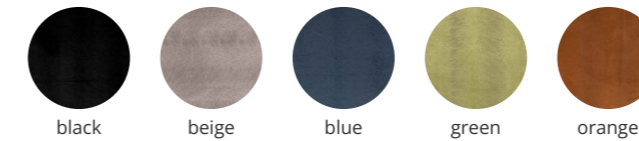

easy care

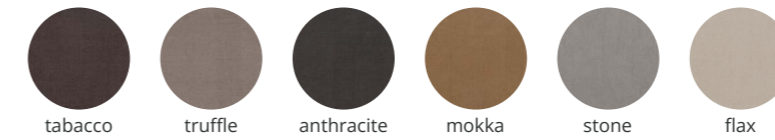

leather *

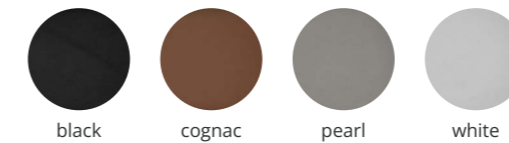

nido chairs

designed by Miel Daenens

indoor

central base

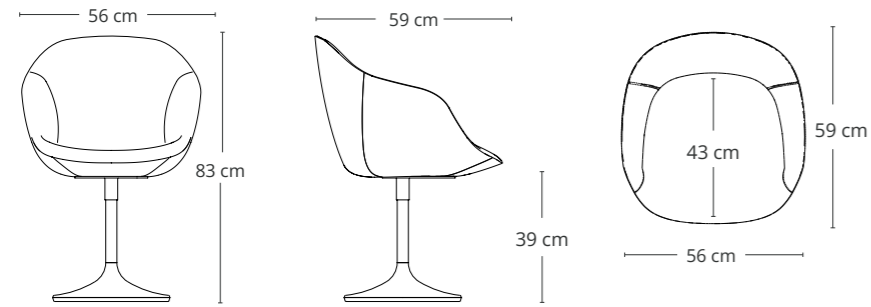

spider base

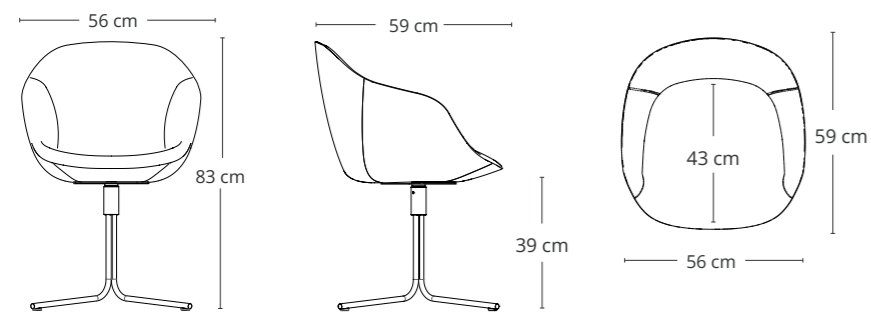

spinning base

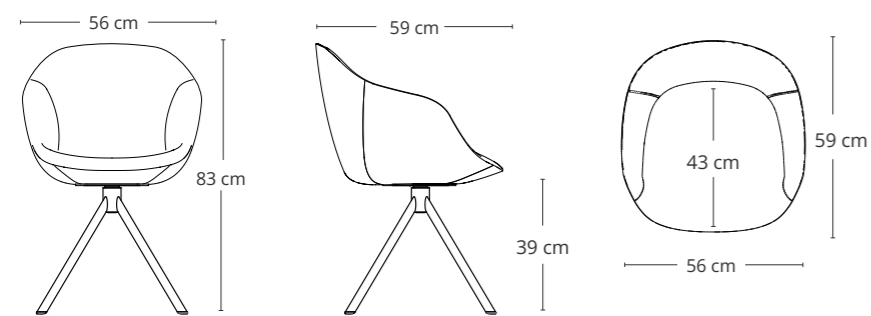

tube base

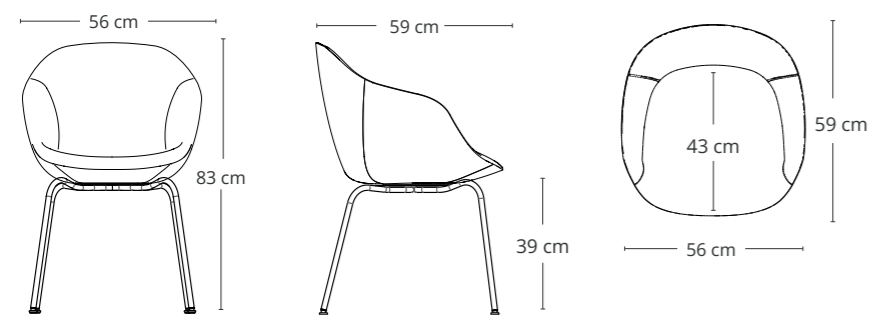

price

	quantity / box	volume (m³)	weight / box (kg)	€			leather-fabric combination*	
				cibo smooth velvet	easy care	tanned leather	cibo smooth velvet	easy care
central base	2	0,15	9	1.065	1.000	1.175	1.140	1.120
spider base	2	0,15	10	800	750	920	880	865
spinning base	2	0,23	11	800	750	920	880	865
tube base	2	0,15	10	800	750	920	880	865

frame

stainless steel lacquered



fabrics

Custom upholstery with customer-provided fabric available. Contact us for further details.

cibo

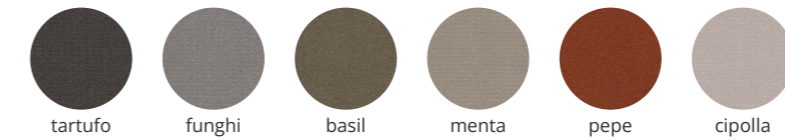

smooth



velvet

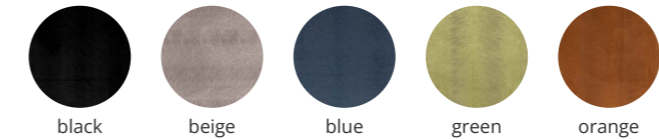

easy care



tanned leather **



olivo chairs

designed by John Ghekiere

indoor

central base

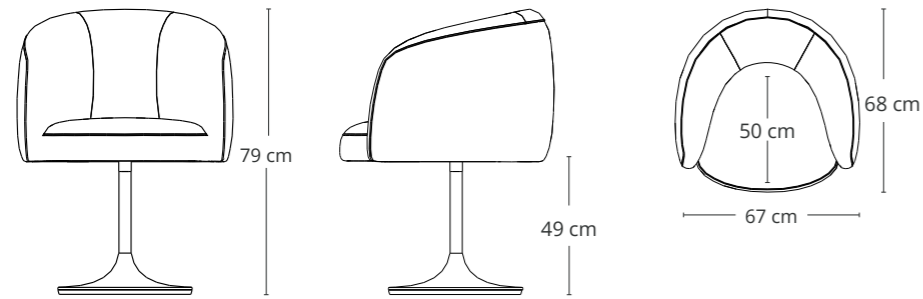

spider base

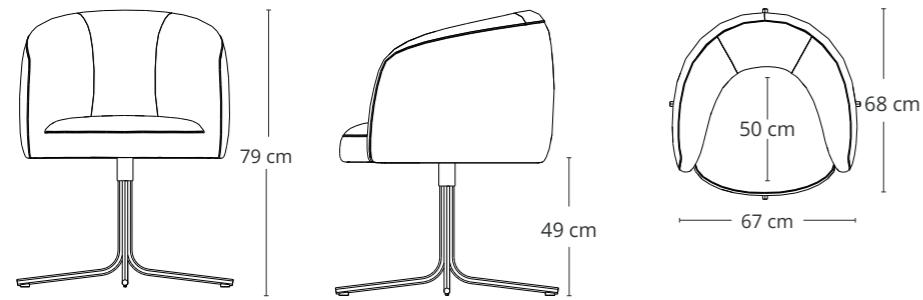

lounge chair

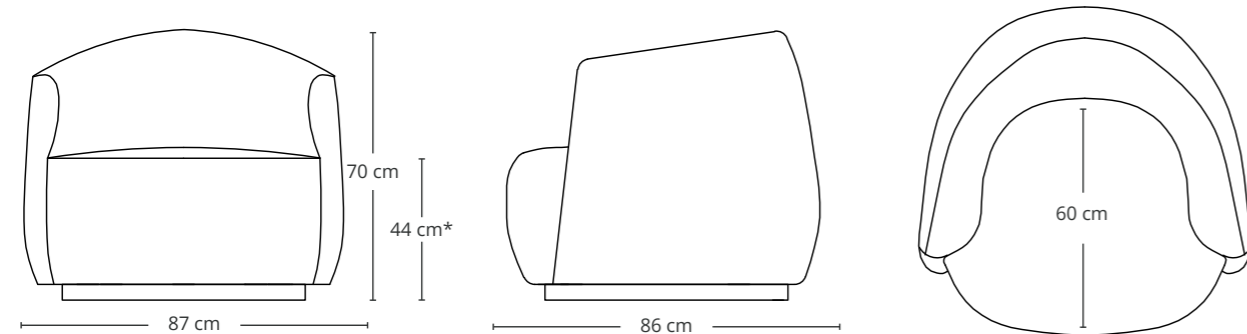

price

	quantity / box	volume (m³)	weight / box (kg)	€ cibo moss-tex
central base	1	0.36	16	1.035
spider base	1	0.36	16	870
lounge chair	1	0.55	31	1.910

frame

metal lacquered



fabrics

Custom upholstery with customer-provided fabric available. Contact us for further details.

cibo

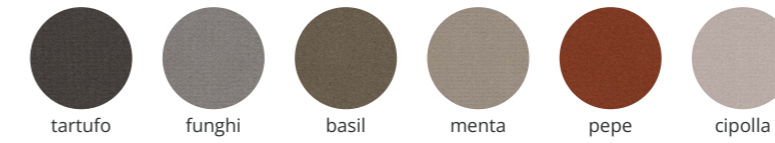

moss-tex



olivo sofas

indoor

sofa 2-seat

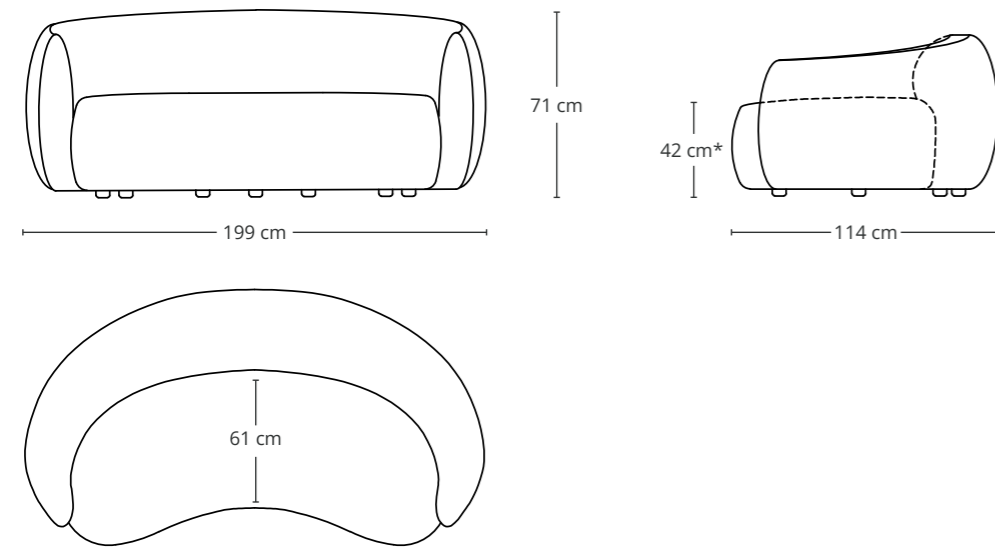

sofa 3-seat

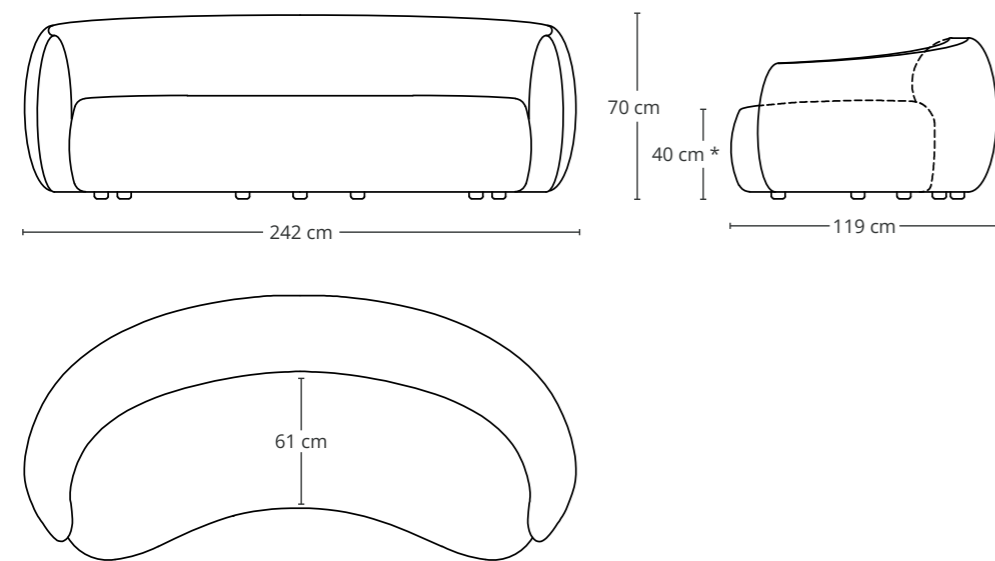

price

	quantity / box	volume (m³)	weight / box (kg)	€
				cibo moss-tex
2-seat	1	1,7	55	3.295
3-seat	1	1,98	65	3.870

fabrics

Custom upholstery with customer-provided fabric available. Contact us for further details.

cibo

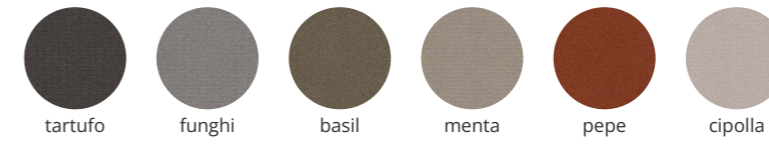

moss-tex



propeller tables

indoor & outdoor

designed by John Ghekiere

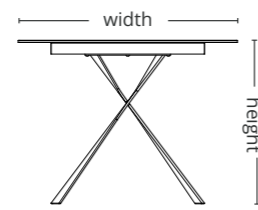
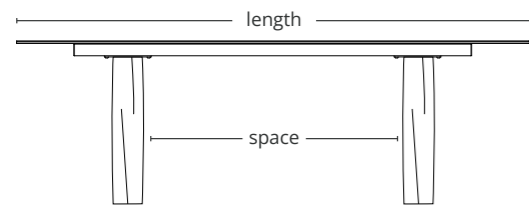

rectangular

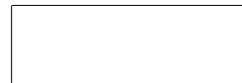

length	width	height	space	seats*	quantity / box / table	volume (m ³)	weight (kg)	€ ceramic top	
								12 mm (nb)	12 mm (sn)
300	100	75	194	8 - 10	4	0,5	127	4.850	5.110
250	100	75	144	8 - 10	4	0,5	118	4.715	4.975
220	100	75	114	8	4	0,5	111	4.530	4.790
200	100	75	94	8	4	0,5	98	3.955	4.215
180	90	75	74	6	4	0,5	95	3.840	4.100

faux elyps



length	width	height	space	seats*	quantity / box / table	volume (m ³)	weight (kg)	€ ceramic top
								12 mm (sn)
300	110	75	194	8 - 10	4	0,5	127	5.240
250	110	75	144	8 - 10	4	0,5	118	5.090
220	110	75	114	8	4	0,5	111	4.890
200	110	75	94	8	4	0,5	98	4.280
180	100	75	74	6	4	0,5	95	4.145

wall table



length	width	height	quantity / box / table	volume (m ³)	weight (kg)	€ ceramic top	
						12 mm (nb)	12 mm (sn)
200	40	75	2	0,5	42	2.440	2.595
160	40	75	2	0,5	42	2.440	2.595

frame

dining tables: lacquered stainless steel
wall tables: lacquered aluminium



ceramic table top

matt

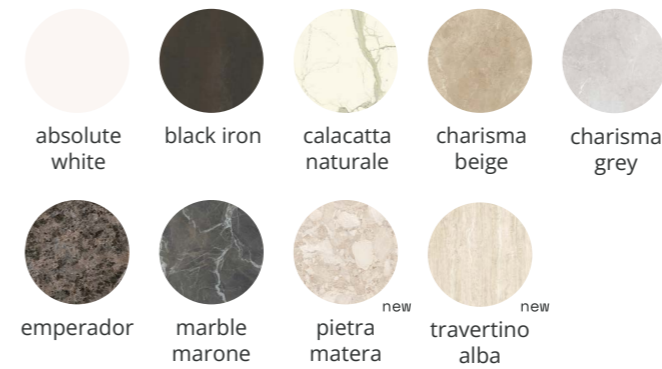

glossy

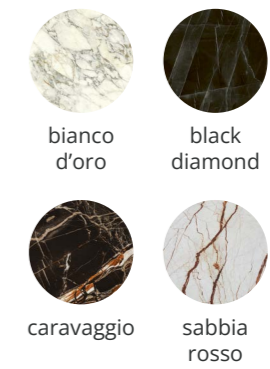
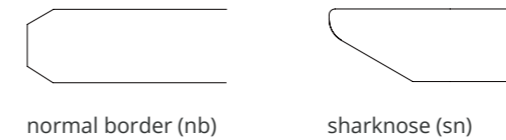

table top finish



+ packaging costs

Outside the BENELUX, a mandatory charge applies for a fumigated wooden crate.

- For dining tables, the charge is € 250.
- For the wall tables, the charge is € 150

If this crate is not selected, the shipment will be at the customer's own risk and expense.

+ supplement

- Adjustment frame or top: closest standard dimension +15%.
- Adjustment frame and top: closest standard dimension +25%.
- Height not adjustable.

pulse dining tables

designed by Mathias De Ferm

indoor & outdoor

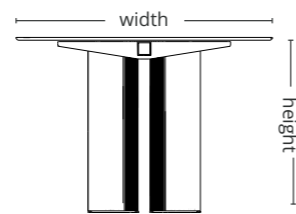
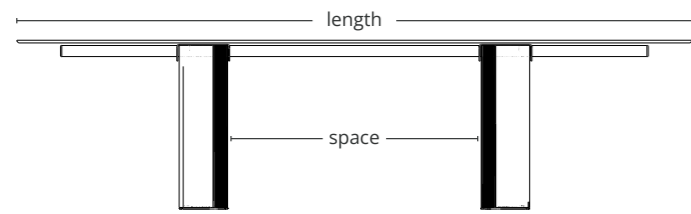

elyps table

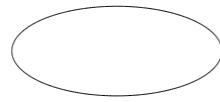

length	width	height	space	seats*	quantity / box / table	volume (m ³)	weight (kg)	€	
								ceramic top 12 mm (sn)	wooden top 32 mm
300	128	75	110	8 - 10	4	0,121	133	4.950	8.750
250	128	75	72,5	6 - 8	4	0,114	122	4.750	7.750
200	100	75	62,5	6	4	0,108	108	4.650	5.990

faux elyps table



length	width	height	space	seats*	quantity / box / table	volume (m ³)	weight (kg)	€	
								ceramic top 12 mm (sn)	wooden top 32 mm
300	110	75	110	10	4	0,122	142	5.250	7.990
250	110	75	72,5	8	4	0,114	124	4.950	6.990
220	110	75	62,5	6 - 8	4	0,110	113	4.750	6.450
200	110	75	62,5	6 - 8	4	0,107	106	4.650	5.990
180	100	75	62,5	6	4	0,103	95	4.550	5.750

frame

lacquered aluminium



ceramic table top

matt

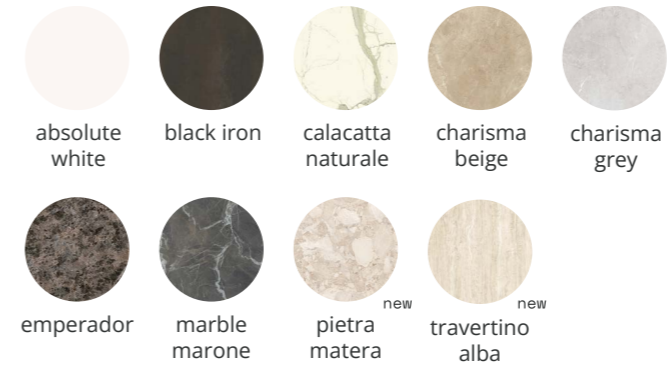

glossy

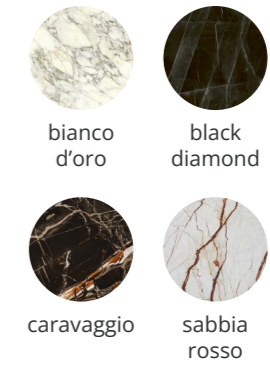

wooden top

indoor

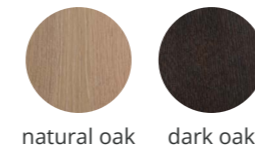
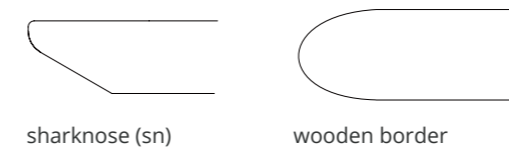

table top finish



+ packaging costs

- Outside the BENELUX, a mandatory charge applies of € 250 for a fumigated wooden crate.
- If this crate is not selected, the shipment will be at the customer's own risk and expense.

+ supplement

- Adjustment frame or top: closest standard dimension +15%.
- Adjustment frame and top: closest standard dimension +25%.
- Height not adjustable.

pulse coffee tables

designed by Mathias De Ferm

indoor & outdoor

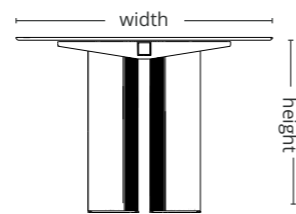
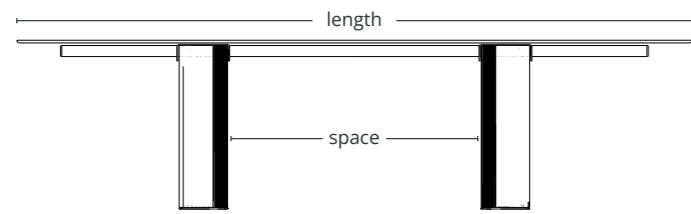

elyps table

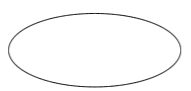

length	width	height	quantity / box / table	volume (m ³)	weight (kg)	€ ceramic top 12 mm (sn)
200	100	27,5	2	0,049	59	3.990
180	90	27,5	2	0,045	49	3.250
160	70	27,5	2	0,04	37	2.590

faux elyps table

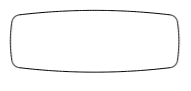

length	width	height	quantity / box / table	volume (m ³)	weight (kg)	€ ceramic top 12 mm (sn)
180	100	27,5	2	0,05	63	3.990
160	85	27,5	2	0,044	49	2.990
140	75	27,5	2	0,042	40	2.590
120	65	27,5	2	0,038	32	2.590

frame

lacquered aluminium



ceramic table top

matt

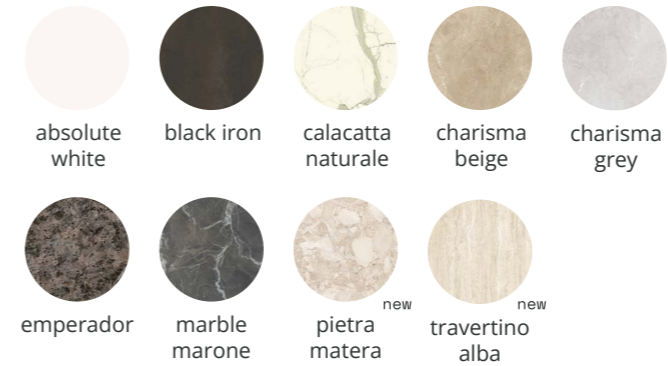

glossy

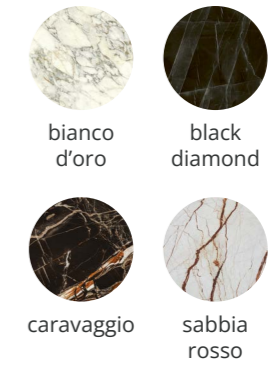
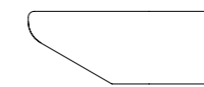

table top finish



sharknose (sn)

+ packaging costs

- Outside the BENELUX, a mandatory charge applies of € 100 for a fumigated wooden crate.
- If this crate is not selected, the shipment will be at the customer's own risk and expense.

+ supplement

- Adjustment frame or top: closest standard dimension +15%.
- Adjustment frame and top: closest standard dimension +25%.
- Height not adjustable.

rafael barstools

designed by John Ghekiere

indoor

barstool high & low

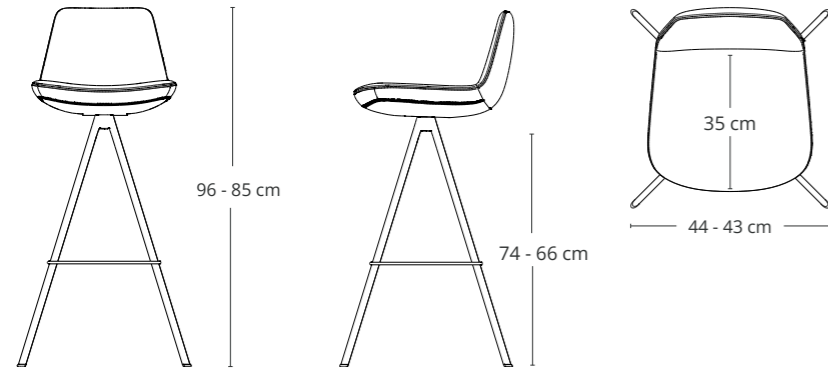

barstool sled base high & low

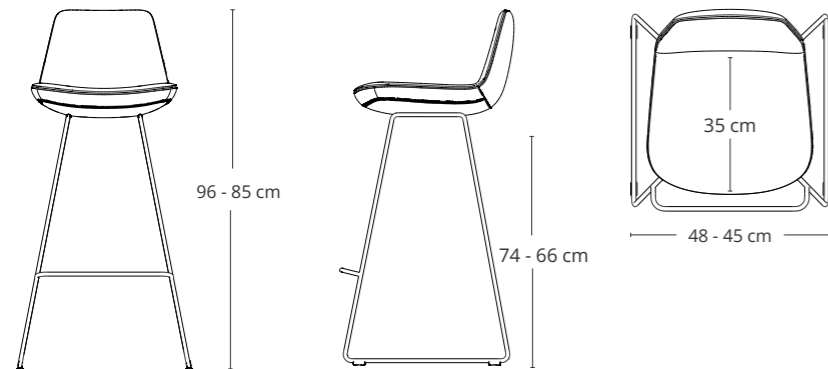

price

	quantity / box	volume (m ³)	weight / box (kg)	€		
				cibo smooth velvet	easy care	vegan leather
barstool high	1	0,21	9	665	615	580
barstool low	1	0,3	10	645	590	555
barstool high sled base	1	0,21	10	570	535	495
barstool low sled base	1	0,3	10	555	505	465

frame

metal lacquered



fabrics

cibo

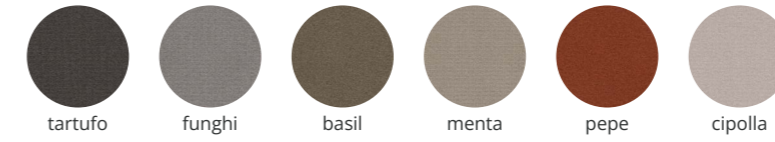

smooth



velvet

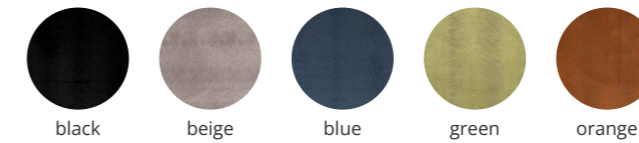

easy care

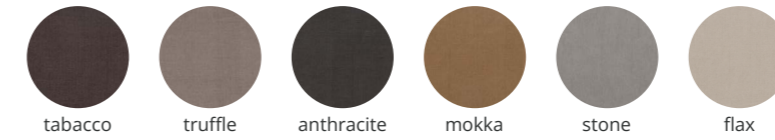

vegan leather



rafael chairs

designed by John Ghekiere

indoor

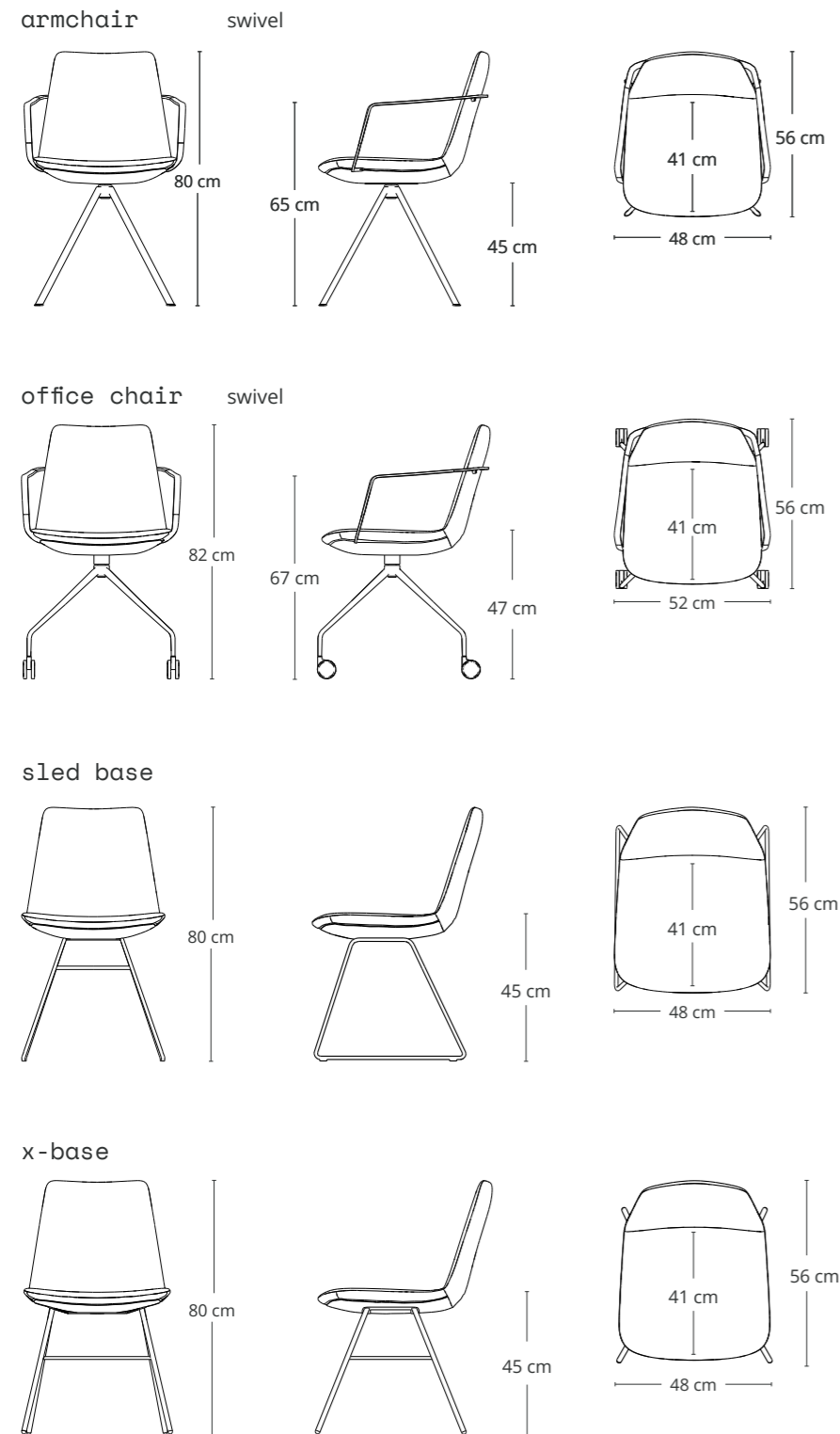

price

	quantity / box	volume (m ³)	weight / box (kg)	€		
				velvet smooth cibo	easy care	vegan leather
armchair	1	0,3	10	725	680	650
office chair	1	0,3	12	805	800	745
sled base	2	0,4	19	685	620	580
x-base	2	0,4	16	630	565	535

frame

metal lacquered



fabrics

cibo



smooth



velvet

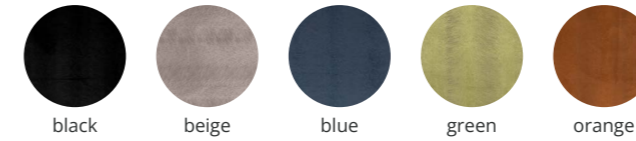

easy care

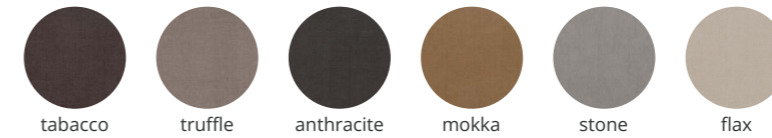

vegan leather



sepia chairs

indoor & outdoor

designed by Mathias De Ferm

tube base

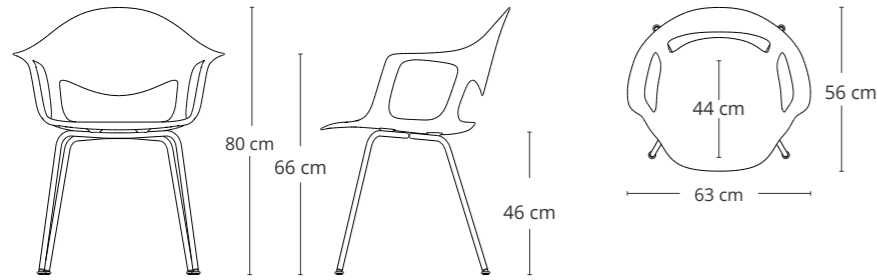

central base

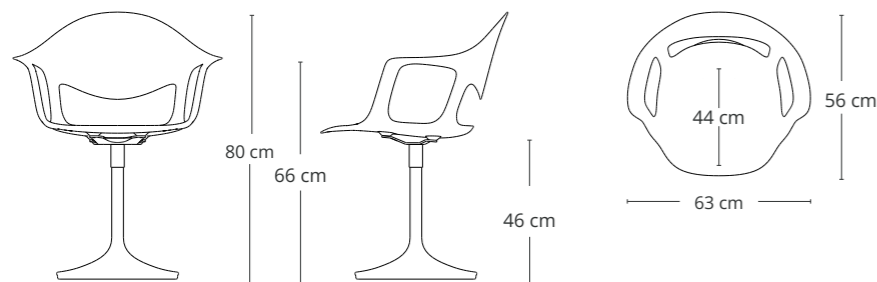

price

	quantity / box	volume (m ³)	weight / box (kg)	€					
				lacquered	cibo velvet	easy care	leather	grain smooth	cushion indoor/outdoor nautic linen
tube base	2	0,2	7	495	-	-	-	-	-
central base	2	0,2	9	795	-	-	-	-	-
cushion				-	195	185	225	195	185

seat

rigid polyurethane coloured in the mass

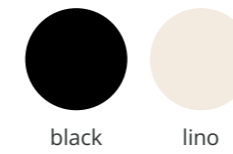

frame

metal lacquered



cushions

cibo

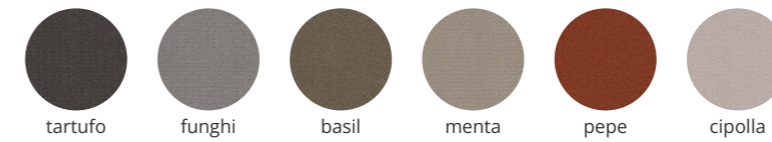

velvet

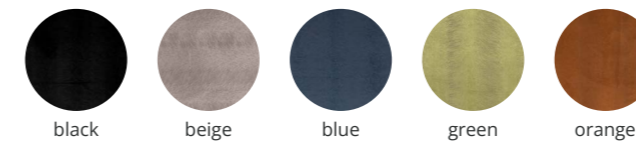

easy care

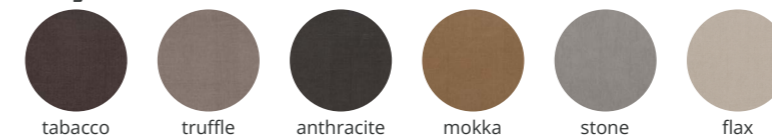

tanned leather*



grain



indoor & outdoor

smooth



indoor & outdoor

nautic linen



indoor & outdoor

* Sepia is only available in our tanned leather

tendo tables

designed by Quinten Bossuyt

indoor & outdoor

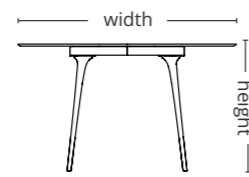
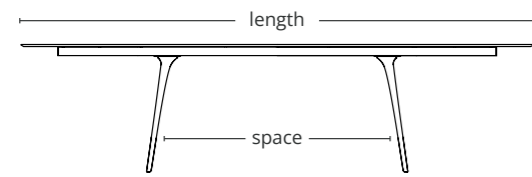

rectangular

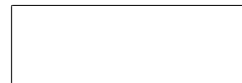

length	width	height	space	seats*	quantity / box / table	volume (m ³)	weight (kg)	€ ceramic top 12 mm (sn)
300	100	75	255	8 - 10	3	0,15	110	4.100
250	100	75	205	8 - 10	3	0,13	94	3.990
220	100	75	175	8	3	0,11	84	3.850
200	100	75	163	8	3	0,10	78	3.820
180	90	75	135	6	3	0,09	66	3.750

faux elyps



length	width	height	space	seats*	quantity / box / table	volume (m ³)	weight (kg)	€ ceramic top 12 mm (sn)
300	110	75	255	8 - 10	3	0,15	121	4.110
250	110	75	205	8 - 10	3	0,13	103	3.990
220	110	75	175	8	3	0,11	86	3.895
200	110	75	163	8	3	0,11	80	3.870
180	100	75	135	6	3	0,09	71	3.810

elyps



length	width	height	space	seats*	quantity / box / table	volume (m ³)	weight (kg)	€ ceramic top 12 mm (sn)
300	128	75	148	8	3	0,16	126	4.600
250	128	75	115	6 - 8	3	0,12	107	4.450
210	128	75	115	6	3	0,12	95	4.250

frame

rectangular and faux elyps: lacquered stainless steel
elyps: lacquered aluminium



ceramic table top

matt

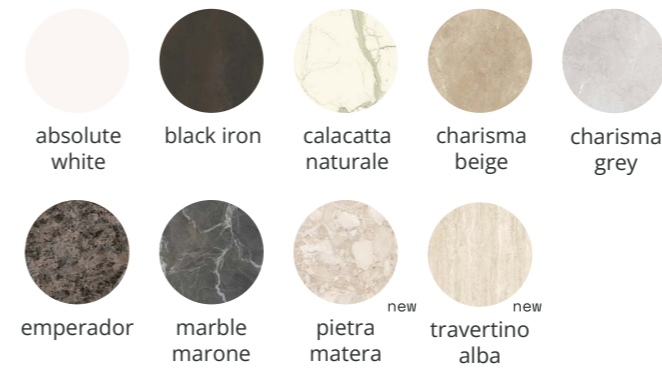

glossy

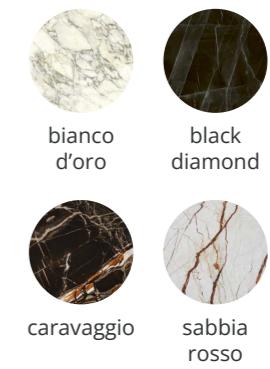
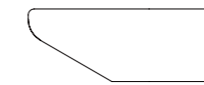

table top finish



sharknose (sn)

+ packaging costs

- Outside the BENELUX, a mandatory charge applies of € 250 for a fumigated wooden crate.
- If this crate is not selected, the shipment will be at the customer's own risk and expense.

+ supplement

- Adjustment frame or top: closest standard dimension +15%.
- Adjustment frame and top: closest standard dimension +25%.
- Height not adjustable.

wire chairs

indoor & outdoor

designed by Mathias De Ferm

dining chair

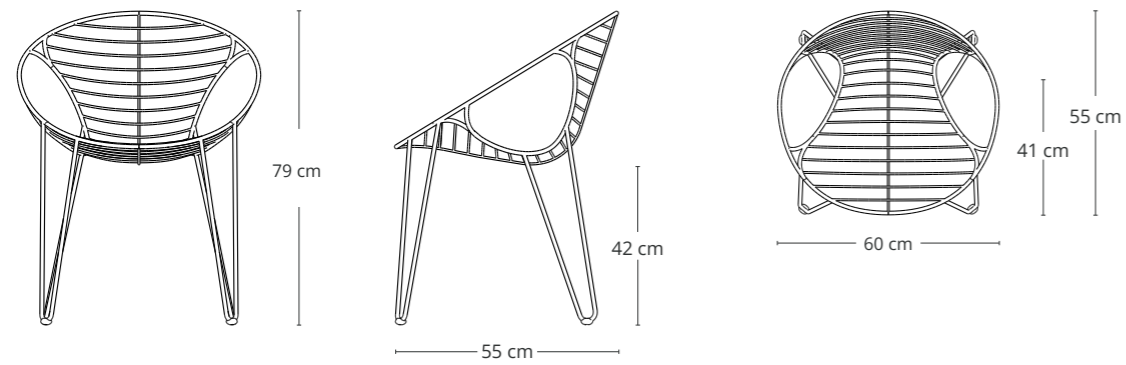

low chair

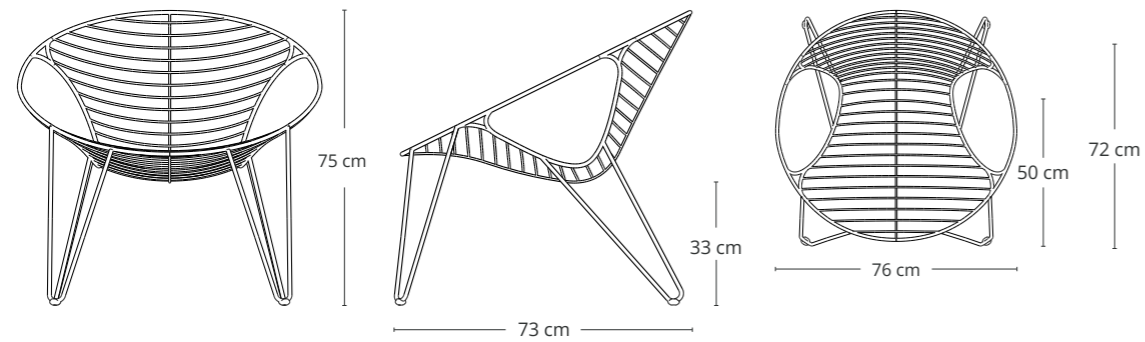

barstool high & low

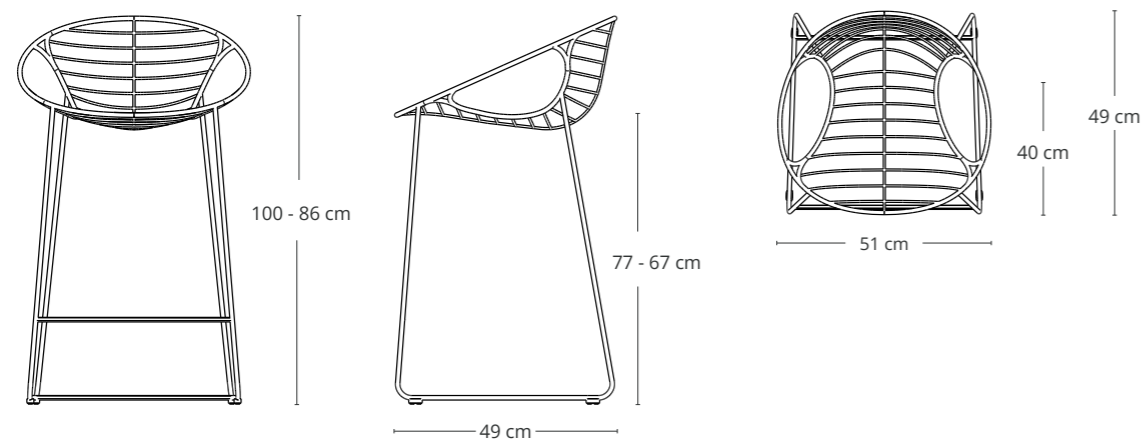

tabouret

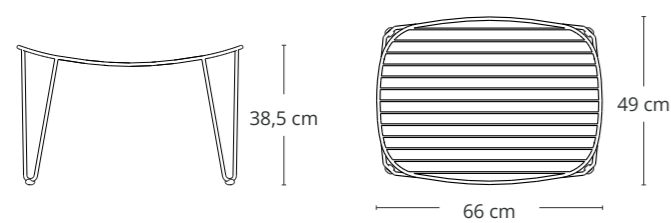

price

	quantity / box	volume (m ³)	weight / box (kg)	€					
				lacquered	cibo velvet	easy care	tanned leather	grain smooth	nautic linen
dining chair	3	0,4	20	695	-	-	-	-	-
dining chair - cushion	10	0,1	2	-	210	165	280	210	165
low chair	2	0,5	20	745	-	-	-	-	-
low chair - cushion	10	0,1	2	-	270	230	350	270	230
barstool high	1	0,3	8	755	-	-	-	-	-
barstool low	1	0,3	8	715	-	-	-	-	-
barstool - cushion	10	0,1	2	-	190	155	250	190	155
tabouret	2	0,15	6	510	-	-	-	-	-
tabouret - cushion	10	0,1	2	-	250	195	295	250	195

frame

stainless steel lacquered



cushions

see next page

wire loungers

designed by Mathias De Ferm

indoor & outdoor

2- seat

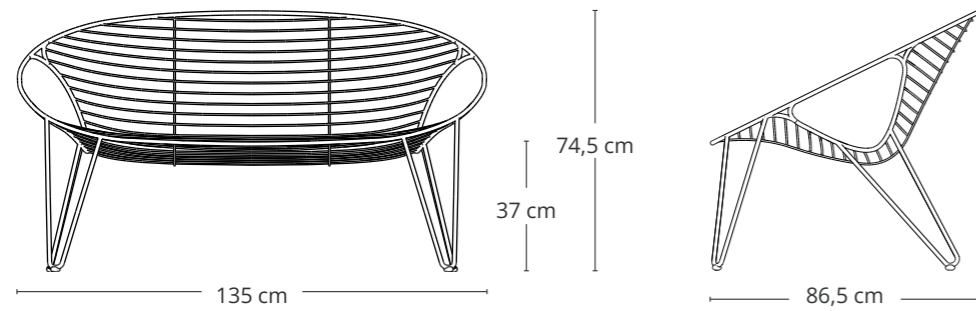

3- seat

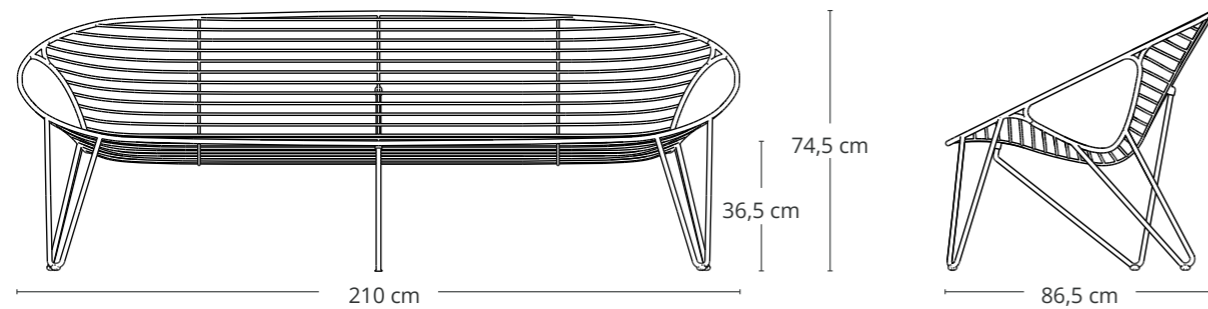

lounger

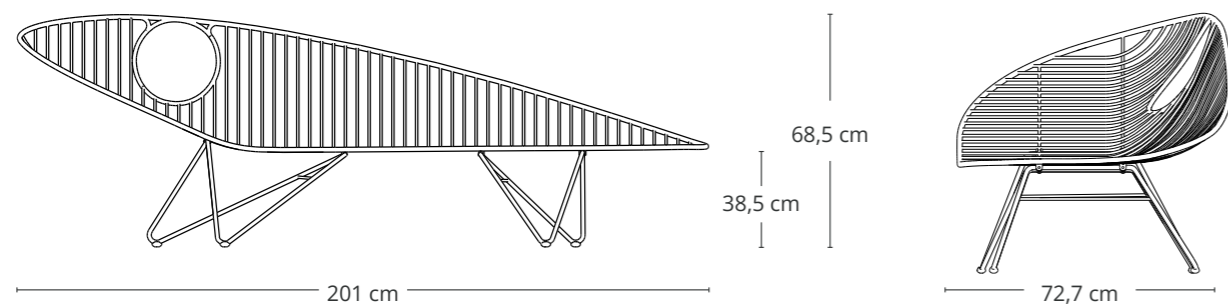

price

	quantity / box	volume (m ³)	weight / box (kg)	€					
				lacquered	cibo velvet	easy care	tanned leather	grain smooth	nautic linen
2-seat	1	1	25	1.795	-	-	-	-	-
2-seat - cushion	4	0,1	2	-	695	640	895	695	640
3-seat	1	1,64	45	2.970	-	-	-	-	-
3-seat - cushion	4	0,1	2	-	960	810	1.270	960	810
lounger	1	1,64	45	3.330	-	-	-	-	-
lounger - cushion	4	0,1	2	-	1.005	865	1.385	1.005	865

frame

stainless steel lacquered



cushions

cibo

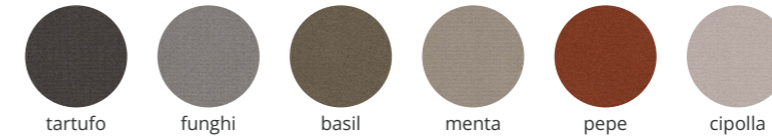

velvet

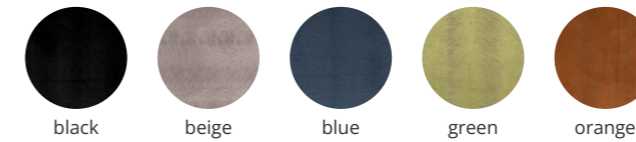

easy care

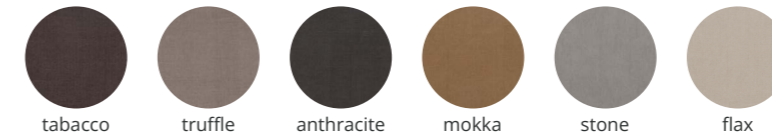

tanned leather *



grain



indoor & outdoor

smooth



indoor & outdoor

nautic linen

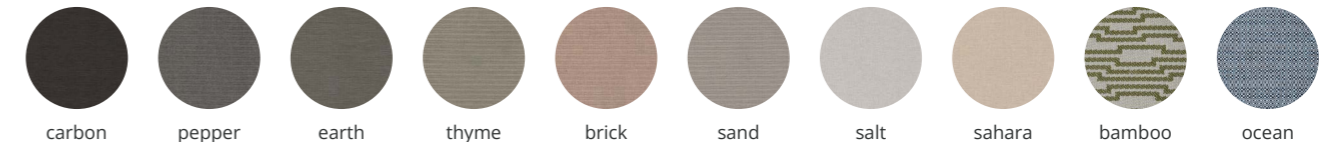

indoor & outdoor

wire daybed

designed by Mathias De Ferm

indoor & outdoor

daybed

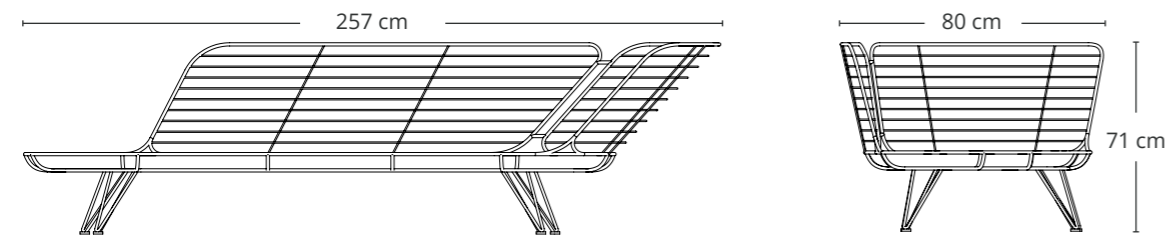

price

	quantity / box	volume (m³)	weight / box (kg)	€ cushion - indoor & outdoor		
				lacquered	grain smooth	nautic linen
daybed	1	1,7	30	3.850	-	-
cushion: daybed			22	-	2.460	2.275
cushion: big back (60 x 38)				-	195	175
cushion: small back (53 x 25)				-	165	150
cushion: small pillow (45 x 45)				-	165	150
cushion: big pillow (60 x 60)				-	195	175

frame

stainless steel lacquered



cushions

grain



smooth



nautic linen



wire dining tables

indoor & outdoor

designed by Mathias De Ferm

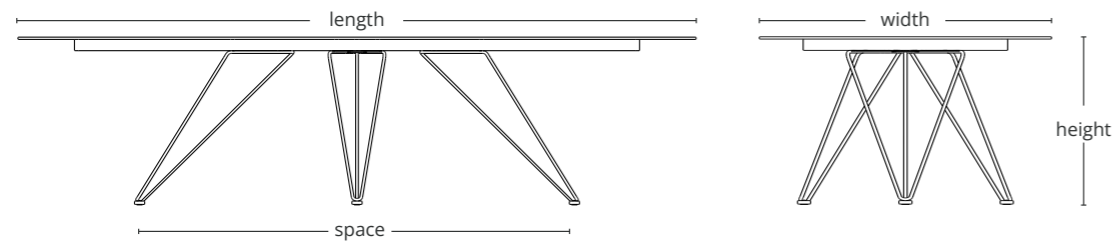

rectangular



length	width	height	space	seats*	quantity / box / table	volume (m ³)	weight (kg)	€ ceramic top	
								12 mm (nb)	12 mm (sn)
300	100	75 / 66	197	8 - 10	4	0,5	107	5.605	5.900
250	100	75 / 66	147	8 - 10	4	0,5	98	5.310	5.605
220	100	75 / 66	108	8	4	0,5	86	5.255	5.555
200	100	75 / 66	108	8	4	0,5	78	4.420	4.725
180	90	75 / 66	99	6	4	0,5	69	4.410	4.700

faux elyps



length	width	height	space	seats*	quantity / box / table	volume (m ³)	weight (kg)	€ ceramic top
								12 mm (sn)
300	110	75 / 66	197	8 - 10	4	0,5	107	6.450
250	110	75 / 66	147	8 - 10	4	0,5	98	6.045
220	110	75 / 66	108	8	4	0,5	86	6.005
200	110	75 / 66	108	8	4	0,5	78	5.050
180	100	75 / 66	108	6	4	0,5	69	5.035

elyps



length	width	height	space	seats*	quantity / box / table	volume (m ³)	weight (kg)	€ ceramic top	
								12 mm (nb)	12 mm (sn)
300	128	75 / 66	147	8 - 10	4	0,5	103	6.045	6.340
250	128	75 / 66	147	6 - 8	4	0,5	87	5.745	6.040
210**	128	75 / 66	147	6	4	0,5	79	5.310	5.605

** For this size, we use the same frame as in the 250 model, which may make the frame visible at the ends.

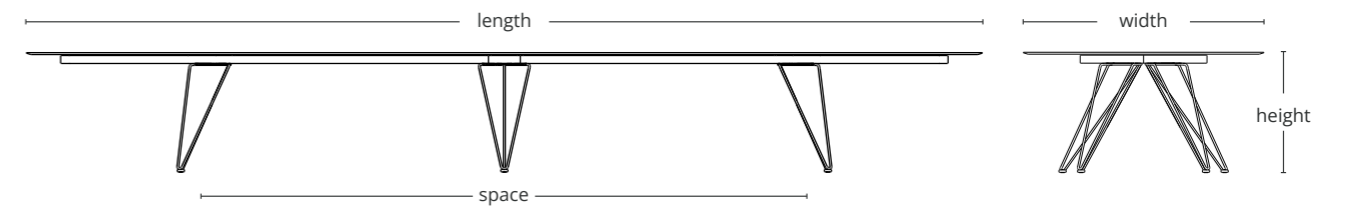

majestic

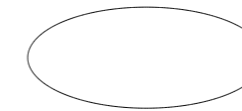

length	width	height	space	seats*	quantity / box / table	volume (m ³)	weight (kg)	€ ceramic top	
								12 mm (nb)	12 mm (sn)
600	150	75 / 66	411	16 - 18	7	1,5	251	13.805	14.630
500	150	75 / 66	311	14 - 16	7	1	221	13.135	13.820
400	150	75 / 66	212	12 - 14	7	0,9	191	12.725	13.280

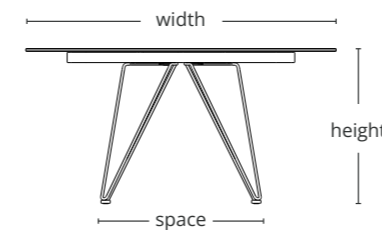

round

width	height	space	seats*	quantity / box / table	volume (m ³)	weight (kg)	€ ceramic top	
							12 mm (nb)	12 mm (sn)
150	75 / 66	99	6 - 7	4	0,5	68	5.145	5.440
120	75 / 66	77	5	4	0,5	64	3.990	4.285

square

width	height	space	seats*	quantity / box / table	volume (m ³)	weight (kg)	€ ceramic top	
							12 mm (nb)	12 mm (sn)
150	75 / 66	99	6 - 8	4	0,5	86	4.420	4.720
130	75 / 66	77	5	4	0,5	78	4.285	4.580

wire coffee tables

indoor & outdoor

designed by Mathias De Ferm

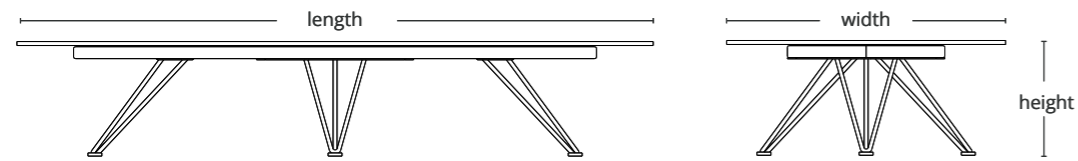

rectangular



length	width	height	quantity / box / table	volume (m ³)	weight (kg)	€ ceramic top	
						12 mm (nb)	12 mm (sn)
150	100	29	2	0,5	57	2.670	2.835
130	70	29	2	0,5	50	2.525	2.695
100	100	29	2	0,5	50	2.525	2.695

elyps

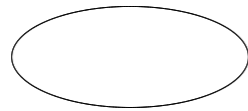

length	width	height	quantity / box / table	volume (m ³)	weight (kg)	€ ceramic top	
						12 mm (nb)	12 mm (sn)
160	70	29	2	0,5	50	2.670	2.835
120	60	29	2	0,5	48	2.525	2.695

frame

stainless steel lacquered



ceramic table top

matt

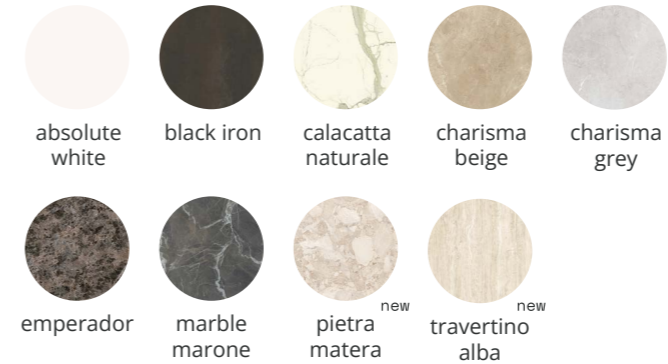

glossy

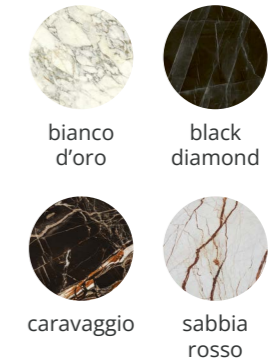
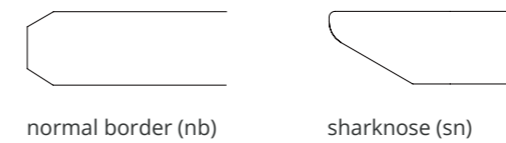

table top finish



+ packaging costs

Outside the BENELUX, a mandatory charge applies for a fumigated wooden crate.

- For dining tables, the charge is € 250.
- Except Dining Round (120 cm) and Dining Square (130 cm), for which the charge is € 150.
- For the Wire Majestic the charge is € 500 (2 x € 250).
- For coffee tables, the charge is € 100.

If this crate is not selected, the shipment will be at the customer's own risk and expense.

+ supplement

- Adjustment frame or top: closest standard dimension +15%.
- Adjustment frame and top: closest standard dimension +25%.
- Height not adjustable.

+ supplement majestic

- Oval cable entry ceramics € 533

table accessories

indoor & outdoor

designed by Cas Moor & Lieven Musschoot

bite

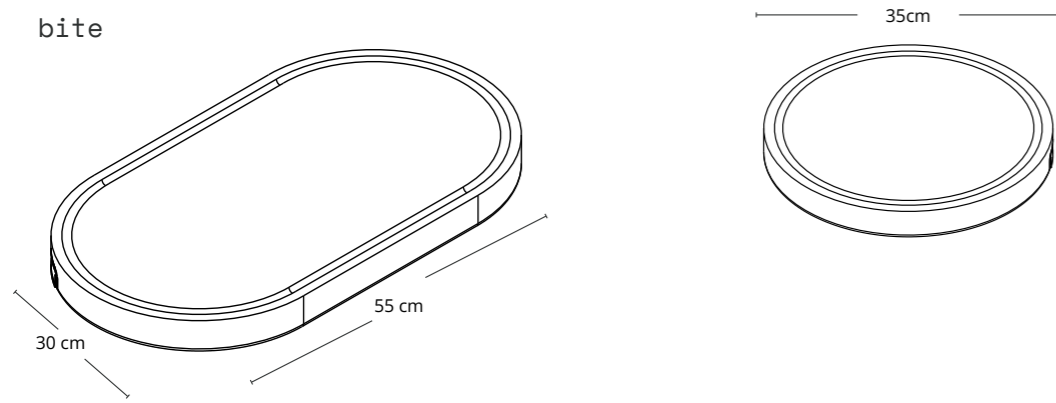

	length	width	€		
			oiled beech	oiled oak	oiled walnut
large	55	30	430	505	610
small	-	35	365	430	510

wood for bite

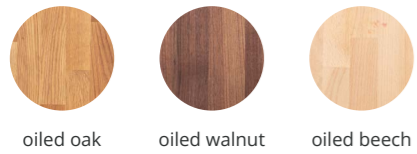

heatt

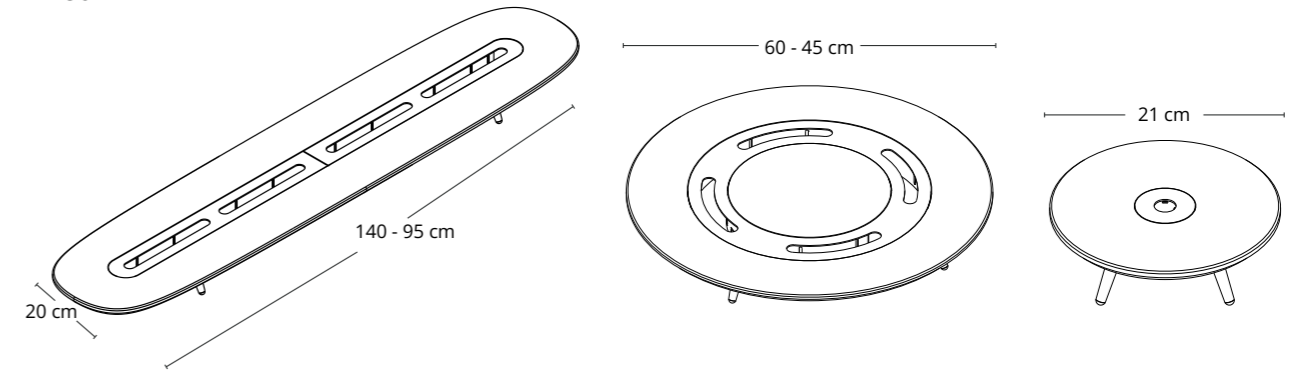

turnable disc

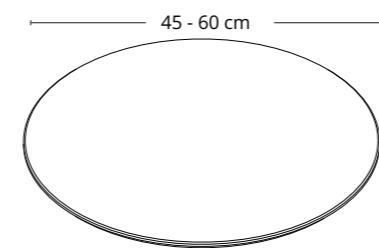

	length	width	€
			ceramic 12 mm
heatt oblong	140	20	800
	95	20	695
heatt round	-	60	910
	-	45	695
turnable disc	-	21	320
	-	60	535
-	-	45	430

ceramic top

matt

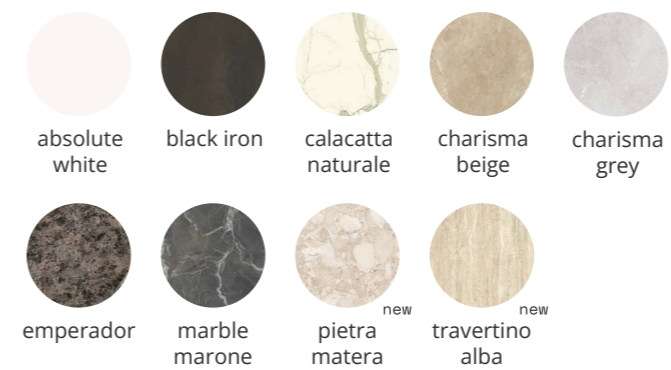

glossy

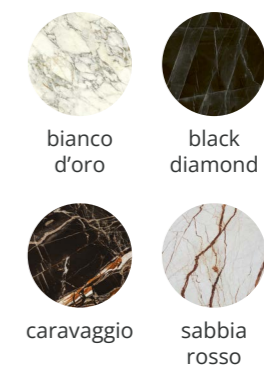

ceramics

Ceramic tabletops consists of minerals that are compressed under high pressure and at a high temperature to create a very dense, homogeneous structure.

The advantages of ceramic tabletops:

- No scratches*
- 100% UV resistant & 100% frost-resistant
- Does not absorb fat, acid, water or wine
- No visible dust
- Easy to maintain

ceramic 12 mm

This is a full ceramic plate with a glass fibre membrane underneath.

* bianco d'oro, black diamond, caravaggio and sabbia rosso are more sensitive to scratches due to a high-gloss layer.

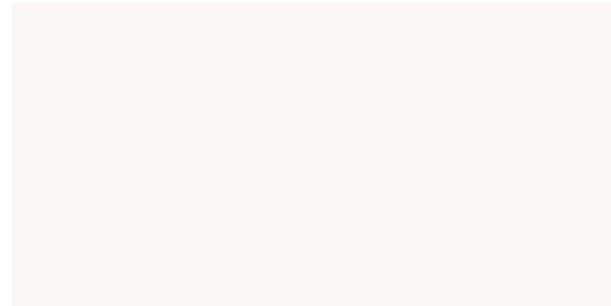

absolute white matt



bianco d'oro glossy

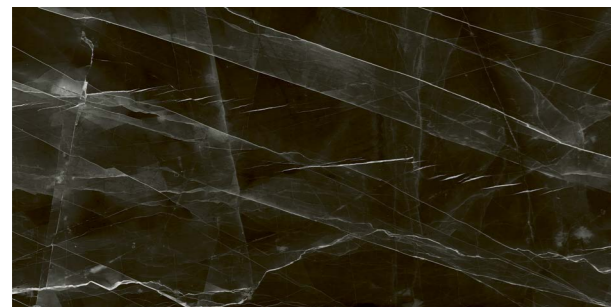

black diamond glossy



black iron matt

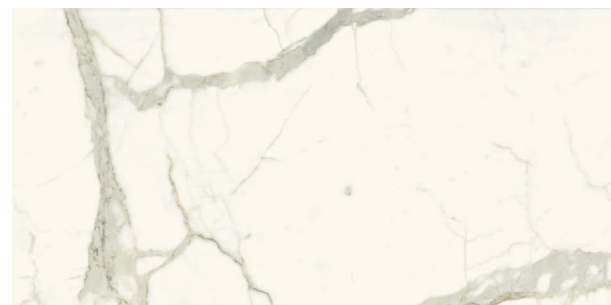

calacatta naturale * matt

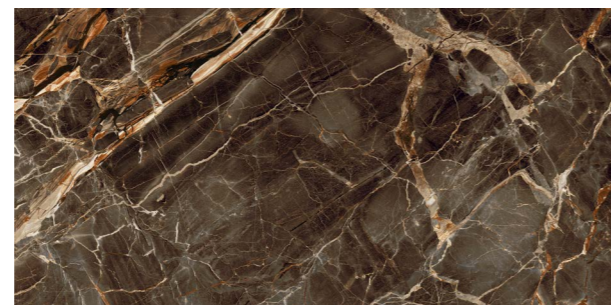

caravaggio glossy



charisma beige * matt



charisma grey * matt



emperador matt



marble marone * matt



pietra matera * matt

new



sabbia rosso glossy



travertino alba * matt

new

wood

Wood has a unique, warm appearance that instantly brings a natural and cozy ambiance to your interior.

Some outstanding features of our wooden table tops:

- Timeless and durable: wood lasts for generations and becomes even more beautiful over time.
- Unique character: no two table tops are alike, thanks to natural wood grains.
- Versatility: perfectly complements both modern and classic interiors.
- Border: our tops have a unique edge finish, making 32 mm and 20 mm solid wood yet elegant.

Handmade craftsmanship

Our wooden table tops are handcrafted in Belgium from premium solid oak. The artisanal craftsmanship is evident in every detail.



natural oak



dark oak

frame

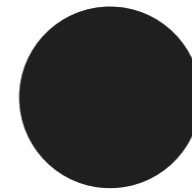

black

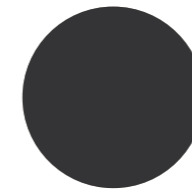

anthracite

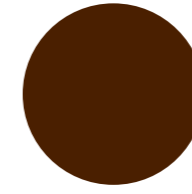

brown

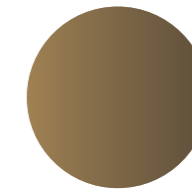

bronze

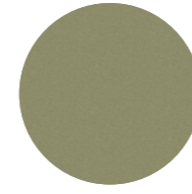

khaki

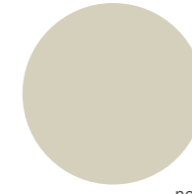

sand

new



lino

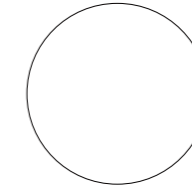

white

fabrics

indoor

cibo

16% cotton, 84% polyester | martindale: 45.000

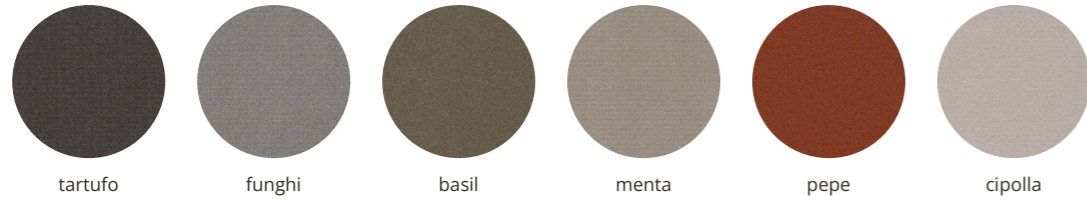

vegan leather

1% polyurethane, 82% polyvinyl chloride, 17% polyester | martindale: > 20.000

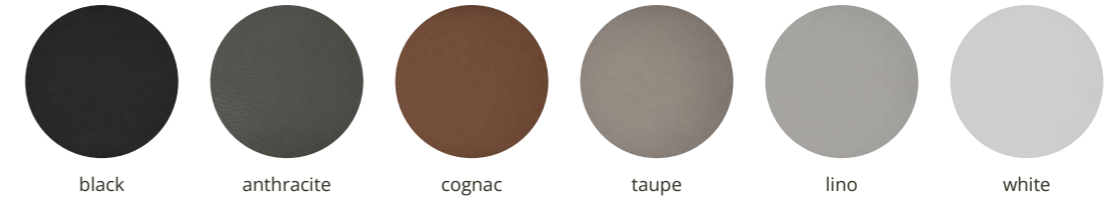

easy care fabrics

100% enhanced micro polyester chenille yarn | martindale: 84.000



velvet

100% polyester | martindale: 50.000

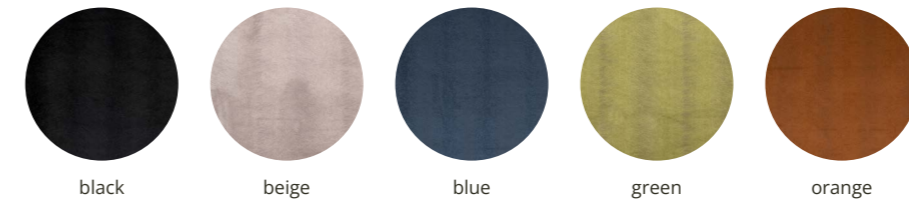

moss-tex

26% acrylic fiber, 17% cotton, 31% polyamide of nylon, 26% polyester | martindale: 100.000

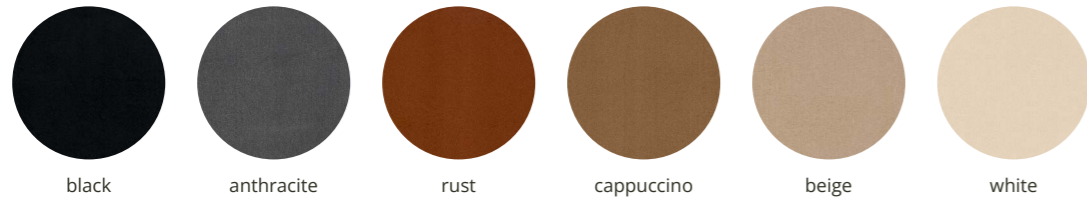

leather

available while stock lasts

100% leather | flexing endurance: no cracks at 20.000 cycles

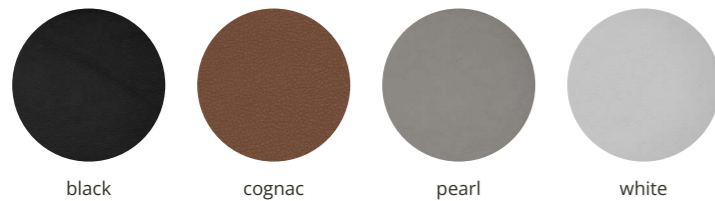

tanned leather

100% leather | flexing endurance: no cracks at 50.000 cycles



fabrics

indoor & outdoor

grain

solution dyed polypropylene chenille (washable) | martindale: 40.000 | color fastness to light >7 | color fastness to weathering > 3-4



nautic linen

solution dyed polypropylene (washable) | martindale: > 35.000 | color fastness to light >7 | color fastness to weathering > 4-5

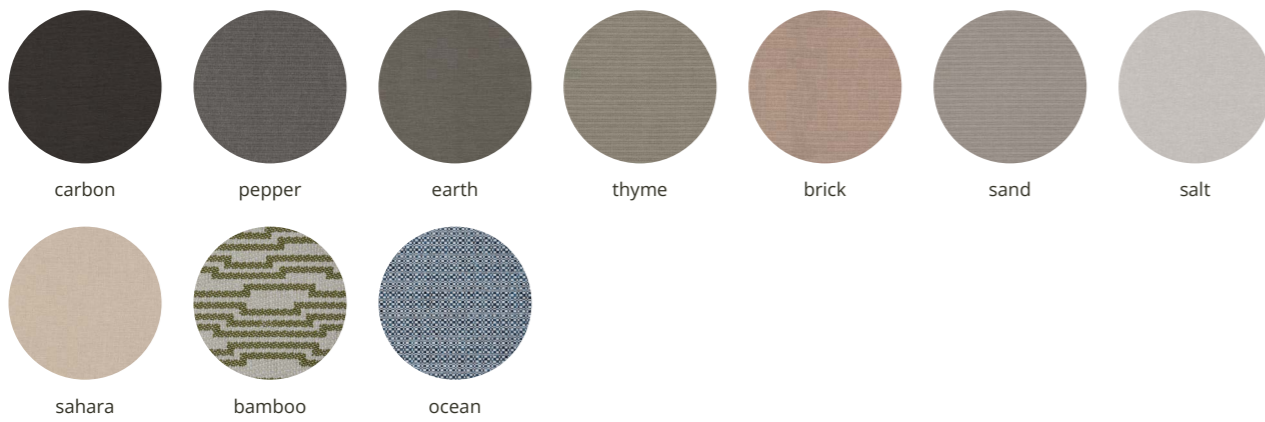

smooth

solution dyed polypropylene chenille (washable) | martindale: > 30.000 | color fastness to light >7 | color fastness to weathering > 4-5



General Conditions and Terms of Sale

01. In order to commit our Company (Ghekiere Industries BVBA), every order must be confirmed by a written Order Confirmation. Each Order Confirmation sent by our Company is considered to be accepted by the client, unless protested within 8 days of reception, and implies the immediate payment of the agreed amount upfront before production is started.

02. Our Company takes all useful steps, necessary in order to respect the terms of delivery; we do not accept any delay penalty.

03. A delay in the delivery may not lead in any case to a cancellation of the order.

04. The goods are dispatched at the own risks of the consignee.

05. All invoices of our Company are to be paid in Kurne, Belgium.

06. Our agents or representatives do not have authority to collect the amount of the invoice except when explicitly stipulated.

07. The risk of currency changes is chargeable to the client.

08. All invoices of our Company are payable within 30 days after invoice date, unless other payment terms for the client are explicitly stipulated in written communication.

09. Any amount unpaid on the due date of the invoice shall, automatically and without prior notice, bear interest at a rate of 2% above the Belgian legal interest rate, with a minimum interest rate of 12%.

10. We reserve the right to increase by 10% the amount of any invoice unpaid on the due date of the invoice. The minimum amount of any such increase shall be 50 EUR.

11. Should an invoice of a client remain unpaid on the due date, all invoices of that client shall immediately become due for payment, regardless of their original due date.

12. Should the client fail to honour his engagements, we may proceed to the cancellation of the contract. Such action shall in no way limit or prejudice our rights to claim damages and interests.

13. If in our opinion there is a deterioration in the creditworthiness of the client on account of measures of judicial execution against the client and/or other negative demonstrable events, we reserve the right to suspend all or part of any contracts in operation and to ask the buyer to provide such guarantees as we may deem proper to ensure the fulfilment by the client of his engagements under the contract. Such request may be made before or after the delivery of all or part of any order. Should the client fail to meet any reasonable demand for such a guarantee, we shall have the right to cancel all or part of any contracts in operation. Such action shall not in any way limit or prejudice our other rights for damages and interests.

14. Notwithstanding delivery and the passing of risk, property in and title to the goods, including full legal and beneficial ownership, shall remain with our Company until we have received payment of the full price of (a) all goods and/or services as the subject of the contract and (b) all other goods and/or services supplied by us to the client under any contract whatsoever. Payment of the full price shall include,

without limitation, the amount of any interest or other sum payable under the terms of this and all other contracts between the client and our Company. The client shall be entitled to transform the goods or to incorporate them in a new product or products. In that case we reserve to our Company the legal and equitable title to the final product or products into which the goods are incorporated or mixed. The client shall store the final products separately and property of these products shall remain with our Company until full payment will have been made to us for the goods. The client may sell the goods in the normal course of his business but on condition that the buyer, in a fiduciary capacity as bailee of the goods, and for so long as he has not fully discharged his debt to us, shall hold and pursue claims for the proceeds of their sale equal to the price of the goods for and on behalf of us. The client shall fully pursue such claims and if necessary shall recover the sums due by legal process. The client shall if so required by our Company, allow us to conduct in the client's name legal proceedings in respect of the amounts due on the sale of the goods. Any sums recovered by us as a result of such proceedings (including sums accepted by us in settlement thereof whether or not equal to the sums claimed) shall be applied to the payment of the amounts due to us from the client and then to the reasonable costs incurred by us in the course of such proceedings. Any balance remaining shall be paid to the client. Prior to the sale of the goods, the client shall, as far as reasonably practicable, store the goods separately from similar goods of the client, mark the goods as our property and shall not remove, obliterate or in any manner alter any label, mark or other means we may have of identifying the goods.

15. Our Company is responsible for the delivery of goods to the client's warehouse. If goods would be damaged visibly at the moment of delivery because of damaged packaging, this has to be indicated by the client's warehouse manager in written on the delivery documentation attached to the delivered goods, mentioning date, name of the warehouse manager and a description of the damage. Furthermore it is extremely important to correctly and thoroughly check all goods at the moment of delivery. All complaints should be reported to our Company within 2 days after reception of the goods, by sending an email to info@joli.be, containing a detailed description of the damage, the exact time when the damage is discovered, and photographs of the damage. Any damage reported more than 2 days after delivery is considered to have been caused at the warehouse of the client and can never lead to a damage claim or exchange by our Company.

16. At the moment that the complaint of the client has been accepted by our Company, we will send a confirmation of exchange, specifying the new delivery date for the exchange of the goods. Our Company is responsible for the return transport; the client is responsible for packaging of the to be returned goods. If these to be returned goods are not properly packaged for transport by the client and get damaged during transport, or the client fails to present these to be returned goods to our transporter, our Company will charge these goods to the client as a regular sale.

17. The terms and conditions of this contract shall not be modified in any way by the drawing or acceptance of a bill of exchange or by any other arrangement, nor shall any such act constitute a novation.

18. Disputes arising from this contract shall be referred to the Courts of Kortrijk or, at our discretion, to the Courts having jurisdiction at the client's domicile.

joli sample cart

We proudly introduced our new sample cart during the Joli Days. A stylish and practical way to present our materials and collections.

It features space for:

- Ceramic samples
- Fabric swatches
- Catalogues

A refined and functional tool for your showroom and available for quick delivery.

Interested? Get in touch with your sales agent for more details.



ceramic top cleaner

This liquid cleaner is perfect to keep your ceramic tabletops in top condition. Use it occasionally for a deep clean and added protection.

Each bottle contains 250 ml. The dealer price is €17.50 per unit, sold in sets of 10 pieces. The retail price for the end customer is €35.

Interested? Contact your sales agent for more information or to restock your supply.



new professional portal

Discover our brand-new Professional Portal. Designed to make your work faster and more efficient. You can now preview and download exactly the images you need, photo by photo, including packshots and more. The portal also gives you quick access to all essential materials such as price lists, catalogs, and collection sheets: all in one central place.

Questions? marketing@joli.be



sketchup warehouse

Integrate our collections into your interior designs. Our models are available on SketchUp, allowing you to use them directly in your 3D visualisations.



timeless design,
endless inspiration